





UK  
CA  
CE

# COMBI521

User manual



**TABLE OF CONTENTS**

1. PRECAUTIONS AND SAFETY MEASURES .....	3
1.1. Preliminary instructions.....	3
1.2. During use .....	4
1.3. After use .....	4
1.4. Definition of measurement (overvoltage) category .....	4
2. GENERAL DESCRIPTION .....	5
2.1. Instrument functions .....	5
3. PREPARATION FOR USE .....	6
3.1. Initial checks .....	6
3.2. Instrument power supply .....	6
3.3. Storage.....	6
4. NOMENCLATURE.....	7
4.1. Instrument description .....	7
4.2. Description of measuring leads.....	7
4.3. Keyboard description.....	8
4.4. Display description .....	8
4.5. Initial screen .....	8
5. GENERAL MENU .....	9
5.1. SET – Instrument settings .....	9
5.1.1. Language .....	9
5.1.2. Country.....	10
5.1.3. Electrical system .....	10
5.1.4. General settings.....	10
5.1.5. Auto Start feature .....	11
5.1.6. Date and time.....	11
5.1.7. Information .....	11
5.1.8. Operator name .....	12
6. OPERATING INSTRUCTIONS.....	13
6.1. AUTO: Automatic test sequence (Ra $\frac{\downarrow}{\uparrow}$ , RCD, M $\Omega$ ).....	13
6.1.1. Anomalous situations.....	20
6.2. DMM: Digital multimeter function .....	21
6.3. RPE: Continuity of protective conductors.....	23
6.3.1. TMR mode .....	25
6.3.2. > $\phi$ < mode .....	26
6.3.3. Anomalous situations.....	27
6.4. Lo $\Omega$ : Continuity of protective conductors with 10A.....	28
6.4.1. Anomalous situations.....	30
6.5. M $\Omega$ : Measurement of insulation resistance .....	31
6.5.1. TMR mode .....	35
6.5.2. AUTO mode .....	36
6.5.3. Anomalous situations.....	37
6.6. RCD: Test on differential switches.....	39
6.6.1. Mode AUTO .....	42
6.6.2. Mode AUTO  .....	43
6.6.3. Mode x $\frac{1}{2}$ , x1, x5.....	44
6.6.4. Mode  .....	45
6.6.5. Mode DD.....	46
6.6.6. Mode CCID (TN systems – USA country) .....	47
6.6.7. Anomalous situations.....	48
6.7. LOOP: Line/Loop impedance and overall earth resistance .....	51
6.7.1. Test types.....	55
6.7.2. Test cable calibration (ZEROLOOP).....	57
6.7.3. STD Mode – Generic test .....	59
6.7.4. Br.Cap mode – Verification of the breaking capacity of protection devices .....	61
6.7.5. TripT - Verification of protection coordination .....	63
6.7.6. Ra $\frac{\downarrow}{\uparrow}$ 2-wire test - Verification of protection against indirect contacts .....	65

6.7.7.	Ra $\ddagger$ 3-wire test - Verification of protection against indirect contacts .....	67
6.7.8.	Verification of protection against indirect contacts (IT systems).....	69
6.7.9.	Verification of protection against indirect contacts (TT systems) .....	71
6.7.10.	Verification of protection against indirect contacts (TN systems).....	73
6.7.11.	Anomalous situations.....	75
6.8.	LoZ: Line/Loop impedance with high resolution .....	78
6.9.	1,2,3: Phase sequence and phase concordance test.....	79
6.9.1.	Anomalous situations.....	82
6.10.	LEAK: Leakage current measurement .....	83
6.11.	AUX: Measure environmental parameters with external probes.....	85
6.12.	$\Delta V\%$ : Voltage drop of mains .....	87
6.12.1.	Anomalous situations.....	90
6.13.	PQA: Measuring mains parameters in single-phase systems .....	93
6.14.	EVSE: Safety checks on recharging stations for electric cars .....	95
7.	STORING RESULTS.....	116
7.1.	Saving measures.....	116
7.2.	Recall of data to display and memory deletion.....	117
8.	CONNECTING THE INSTRUMENT TO THE PC.....	118
9.	MAINTENANCE.....	119
9.1.	General information .....	119
9.2.	Replacement of the batteries .....	119
9.3.	Cleaning the instrument.....	119
9.4.	End of life .....	119
10.	TECHNICAL SPECIFICATIONS .....	120
10.1.	Technical characteristics .....	120
10.2.	General characteristics.....	126
10.3.	Environmental conditions for use.....	126
10.4.	Accessories .....	126
11.	SERVICE.....	127
11.1.	Warranty conditions.....	127
11.2.	Service .....	127
12.	THEORETICAL APPENDIXES.....	128
12.1.	Continuity of protective conductors.....	128
12.2.	Insulation resistance.....	128
12.2.1.	Measurement of polarization index (PI) .....	130
12.2.2.	Dielectric Absorption Ratio (DAR).....	130
12.3.	Checking circuit separation.....	131
12.4.	Test on differential switches (RCD).....	133
12.5.	VerifICATION of the breaking capacity of protection devices .....	134
12.6.	Verify of protection against indirect contacts in TN systems .....	135
12.7.	Ra $\ddagger$ test in TN systems .....	137
12.8.	Verify of protection against indirect contacts in TT systems .....	138
12.9.	Verify of protection against indirect contacts in IT systems .....	139
12.10.	Verify of protection coordination L-L, L-N and L-PE .....	140
12.11.	Verifiy of voltage drop on MAINS.....	142
12.12.	Voltage and current Harmonics .....	143
12.12.1.	Presence of harmonics: causes.....	144
12.12.2.	Presence of harmonics: consequences.....	145
12.13.	Calculation of powers and power factors .....	146

## 1. PRECAUTIONS AND SAFETY MEASURES

The instrument has been designed in compliance with guidelines IEC/EN61557, BS7671 17th and 18th editions and IEC/EN61010, relevant to electronic measuring instruments. Before and after carrying out the measurements, carefully observe the following instructions:

- Do not carry out any voltage or current measurement in humid environments.
- Do not carry out any measurements in case gas, explosive materials or flammables are present, or in dusty environments.
- Avoid any contact with the circuit to be measured if no measurements are being carried out.
- Avoid contact with exposed metal parts, with unused measuring leads, etc.
- Do not carry out any measurement in case you find anomalies in the instrument such as deformations, breaks, substance leaks, absence of display on the screen, etc.
- Pay special attention when measuring voltages higher than 25V in special environments (such as construction sites, swimming pools, etc.) and higher than 50V in normal environments, since a risk of electrical shock exists.
- Only use original accessories.

The following symbols are used in this manual:



CAUTION: observe the instructions given in this manual; improper use could damage the instrument, its components or create dangerous situations for the operator



High voltage danger: electrical shock hazard



Double insulation



AC voltage or current



DC voltage or current



Connection to earth



The symbol indicates that the instrument must not be connected to systems with phase-to-phase rated delta voltage higher than 415V

### 1.1. PRELIMINARY INSTRUCTIONS

- **This instrument has been designed for use in the environmental conditions specified in § 10.3 . Do not use in different environmental conditions.**
- The instrument may be used for measuring and verifying the safety of electrical systems. Do not use on systems exceeding the limit values specified in § 10.1
- We recommend following the normal safety rules devised to protect the user against dangerous currents and the instrument against incorrect use.
- Only the accessories supplied with the instrument guarantee compliance with safety standards. They must be in good conditions and be replaced with identical models, when necessary.
- Make sure the batteries are correctly installed.
- Before connecting the test leads to the circuit being measured, check that the desired function has been selected.

## 1.2. DURING USE

Please carefully read the following recommendations and instructions:



### CAUTION

Failure to comply with the caution notes and/or instructions may damage the instrument and/or its components or be a source of danger for the operator.

- Before changing function, disconnect the test leads from the circuit under test.
- When the instrument is connected to the circuit under test, never touch any terminal, even if unused.
- Avoid measuring resistance if external voltages are present. Even if the instrument is protected, excessive voltage could cause damage.

## 1.3. AFTER USE

When measurements are completed, turn off the instrument by pressing and holding the **ON/OFF** key for some seconds. If the instrument is not to be used for a long time, remove the batteries and follow the instructions given in § 3.3.

## 1.4. DEFINITION OF MEASUREMENT (OVERVOLTAGE) CATEGORY

Standard "IEC/EN61010-1: Safety requirements for electrical equipment for measurement, control and laboratory use, Part 1: General requirements" defines what measurement category, commonly called overvoltage category, is. § 6.7.4: Measured circuits, reads: circuits are divided into the following measurement categories:

- **Measurement category IV** is for measurements performed at the source of a low-voltage installation.  
*Examples are electricity meters and measurements on primary overcurrent protection devices and ripple control units.*
- **Measurement category III** is for measurements performed on installations inside buildings.  
*Examples are measurements on distribution boards, circuit breakers, wiring, including cables, bus-bars, junction boxes, switches, socket-outlets in fixed installation, and equipment for industrial use and some other equipment, for example, stationary motors with permanent connection to fixed installation.*
- **Measurement category II** is for measurements performed on circuits directly connected to the low-voltage installation.  
*Examples are measurements on household appliances, portable tools and similar equipment.*
- **Measurement category I** is for measurements performed on circuits not directly connected to MAINS.  
*Examples are measurements on circuits not derived from MAINS, and specially protected (internal) MAINS-derived circuits. In the latter case, transient stresses are variable; for that reason, the standard requires that the transient withstand capability of the equipment is made known to the user.*

## 2. GENERAL DESCRIPTION

### 2.1. INSTRUMENT FUNCTIONS

The instrument can perform the following tests:

- **RPE** Continuity test of earth, protective and equipotential conductors with test current higher than 200mA and open-circuit voltage between 4V and 24V.
- **MΩ** Measurement of insulation resistance with continuous test voltage of 50V, 100V, 250V, 500V or 1000V DC.
- **LOOP** Measurement of line/fault loop impedance P-N, P-P, P-E with calculation of the prospective short-circuit current, overall earth resistance without causing the RCD's tripping ( $RA_{\frac{1}{2}}$ ), check of the breaking capacity of magnetothermal protections (MCB) and fuses, protection check in case of indirect contacts with 2-wire and 3-wire connection
- **LoZ** Measurement of line impedance/Loop P-N, P-P, P-E with calculation of the prospective short-circuit current with high resolution (0.1mΩ) (by means of optional accessory IMP57)
- **ΔV%** Measurement of percentage voltage drop on mains.
- **LoΩ** Continuity test of earth, protective and equipotential conductors with test current higher than 10A (by means of optional accessory EQUITEST)
- **RCD** Test on molded-case standard, General and Selective RCDs of type A/F ( $\sim/\sim$ ), AC ( $\sim$ ), B/B+ ( $\sim/\sim+$ ), DD and CCID ( $\sim, \sim$ ) (country USA) of the following parameters: tripping time, tripping current, contact voltage.
- **AUTO** Automatic sequence measurements of  $RA_{\frac{1}{2}}$ , RCD, MΩ functions with 3-wire connection.
- **1,2,3** Indication of phase sequence with 1-terminal method.
- **DMM** Multimeter function for Phase-Neutral, Phase-Phase, Phase-PE voltage and frequency measurements.
- **AUX** Measurement of environmental parameters (illuminance with white light source and LED source, air temperature, humidity) by means of optional external probes and DC voltage signals
- **PQA** Real time measurement of main parameters (powers, harmonics, power factor/cosφ) in Single phase systems
- **LEAK** Measurement of leakage current (by means of the optional accessory HT96U)
- **EVSE** Automatic sequence of safety tests on mode 2 and 3 electric car charging stations (by means of optional accessory EV-TEST100 and Type 1 / Type 2 connectors)

### **3. PREPARATION FOR USE**

#### **3.1. INITIAL CHECKS**

Before shipping, the instrument has been checked from an electric as well as a mechanical point of view. All possible precautions have been taken so that the instrument is delivered undamaged. However, we recommend checking it to detect any damage possibly suffered during transport. In case anomalies are found, immediately contact the Dealer. We also recommend checking that the packaging contains all the components. In case of discrepancy, please contact the Dealer. In case the instrument should be returned, please follow the instructions given in § 11.

#### **3.2. INSTRUMENT POWER SUPPLY**

The instrument is powered by 6x1.5V alkaline batteries of type AA LR06 supplied with the instrument. The “” symbol indicates the charge level of the batteries. To replace the batteries, refer to § 9.2.

**The instrument is capable of keeping data stored even without batteries.**

The instrument has an AutoPower OFF function (which can be deactivated) after 10 minutes' idling.

#### **3.3. STORAGE**

In order to guarantee precise measurement, after a long storage time under extreme environmental conditions, wait for the instrument to come back to normal condition (see § 10.3).

4. NOMENCLATURE

4.1. INSTRUMENT DESCRIPTION

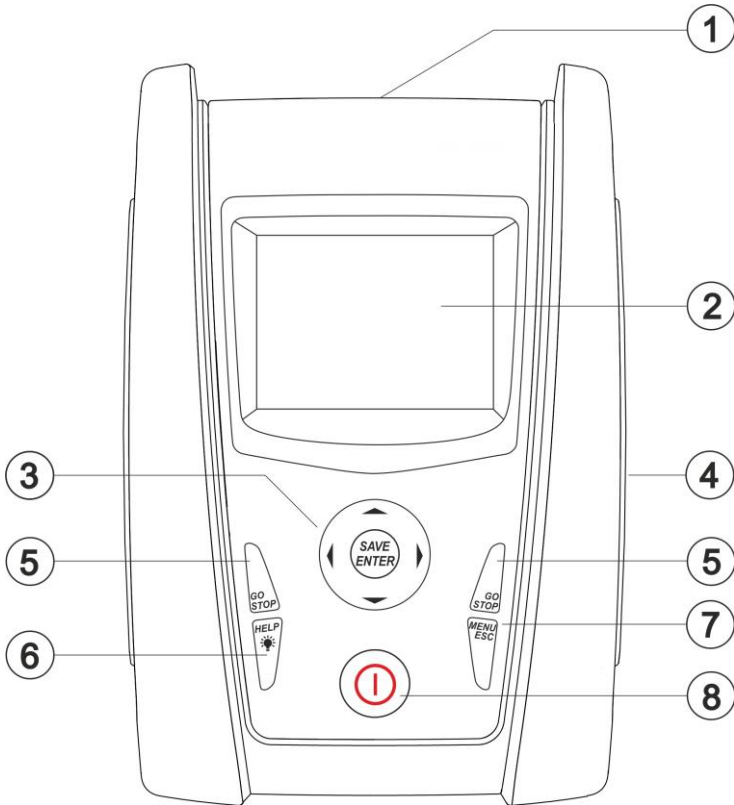

**CAPTION:**

- 1. Inputs
- 2. LCD display
- 3. ▼, ▲, ►, ◀, **SAVE/ENTER** keys
- 4. Compartment of the connector for optical cable/USB port C2006
- 5. **GO/STOP** key
- 6. **HELP** key
- 7. **ESC/MENU** key
- 8. **ON/OFF** key

Fig. 1: Description of the front part of the instrument

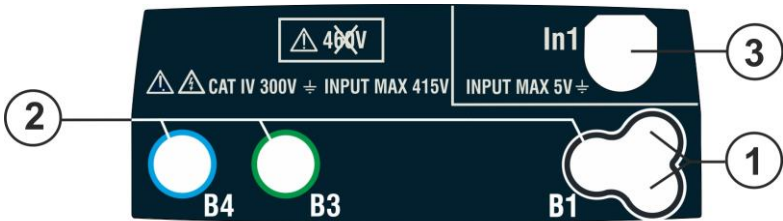

**CAPTION:**

- 1. Connector for remote switch probe
- 2. **B1, B3, B4** inputs
- 3. **In1** input

Fig. 2: Description of the upper part of the instrument

**CAUTION**



The instrument checks voltage on PE by comparing the voltage at B4 input to the ground potential induced on the instrument's side through the user's hand. Therefore, in order to check voltage on PE, **it is mandatory to hold the instrument case on the left or on the right side.**

4.2. DESCRIPTION OF MEASURING LEADS

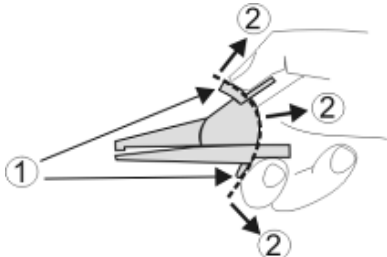

**CAPTION:**

- 1. Hand protection
- 2. Safe area

Fig. 3: Description of measuring leads

### 4.3. KEYBOARD DESCRIPTION

The keyboard includes the following keys:



**ON/OFF** key to switch on/off the instrument



**ESC** key to exit the selected menu without confirming  
**MENU** key to go back to the general menu at any time



◀ ▶ ▲ ▼ keys to move the cursor through the different screens in order to select the desired programming parameters  
**SAVE/ENTER** key to save the selected setup parameters (**SAVE**) and to select the desired function (**ENTER**) from the menu



**GO** key to start measurement  
**STOP** key to stop measurement



**HELP** key to access the online help and display the possible connections between the instrument and the system for each selected function  
 key (**continuous pressure**) to adjust the display backlight

### 4.4. DISPLAY DESCRIPTION

The display is a COG LCD module, 128x128 points. The first line of the display indicates the type of active measurement, the date/time and the battery charge indication.

RPE	15/10 – 18:04	
R = - - - Ω		
I <sub>test</sub> = - - - mA		
Measuring...		
STD	2.00Ω	0.12Ω
MODE	Lim	> φ<

### 4.5. INITIAL SCREEN

When switching on the instrument, the initial screen appears for a few seconds. It shows:

- The instrument model
- The manufacturer
- The serial number (SN:) of the instrument
- The internal Hardware (HW:) and Firmware (FW:) versions of the instrument
- The date of instrument calibration (Calibration date:)

<b>COMBI521</b>
<b>HT ITALIA</b>
SN: 25100100
HW: 02
FW: 2.14
Calibration date: 15/04/2025

After a few seconds, the instrument switches to general menu screen.

## 5. GENERAL MENU

Pressing the **MENU/ESC** key in any condition of the instrument allows going back to the general menu in which internal parameters may be set and the desired measuring function may be selected.

MENU	15/10 – 18:04
AUTO	: Ra $\frac{1}{\Omega}$ , RCD, M $\Omega$
DMM	: Voltage/Freq.
<b>RPE</b>	<b>: Continuity</b>
Lo $\Omega$	: 10A RPE.Test
M $\Omega$	: Insulation
RCD	: Auto, Ramp, Man
LOOP	: ZE/ZS Impedance

MENU	15/10 – 18:04
LoZ	: High Res. Loop
1,2,3	: Phase Sequence
LEAK	: Leakage
AUX	: Environmental
$\Delta$ V%	: Voltage drop
PQA	: Power Analyser
EVSE	: EVSE Safety Test.

MENU	15/10 – 18:04
SET	: Settings
MEM	: Data saved
PC	: Data transfer

Upon selecting one of the listed measurements with the cursor and confirming with **ENTER**, the instrument shows the desired measurement on the display.

### 5.1. SET – INSTRUMENT SETTINGS

Move the cursor to **SET** by means of the arrow keys (**▲**, **▼**) and confirm with **ENTER**. Subsequently, the displays shows the screen which allows accessing the various instrument settings.

The settings will remain valid also after switching off the instrument.

SET	15/10 – 18:04
<b>Language</b>	
Country	
Electrical system	
General settings	
Date and time	
Information	
Operator Name	

#### 5.1.1. Language

Move the cursor to **Language** by means of the arrow keys (**▲**, **▼**) and confirm with **ENTER**. Subsequently, the display shows the screen which allows setting the instrument language.

Select the desired option by means of the arrow keys (**▲**, **▼**). To store settings, press the **ENTER** key, to quit without confirming the changes made, press the **ESC** key.

SET	15/10 – 18:04
<b>English</b>	
Italiano	
Español	
Deutsch	
Français	
Portugues	

### 5.1.2. Country

Move the cursor to **Country** by means of the arrow keys (**▲**,**▼**) and confirm with **ENTER**. Subsequently, the display shows the screen which allows selecting the country of reference, which will influence the LOOP and  $R_{a\frac{1}{2}}$  measurements. Select the desired option by means of the arrow keys (**▲**,**▼**). To store settings, press the **ENTER** key, to quit without confirming the changes made, press the **ESC** key.



### 5.1.3. Electrical system

Move the cursor to **Electrical system** by means of the arrow keys (**▲**,**▼**) and confirm with **ENTER**. Subsequently, the display shows the screen to set the following parameters:

- **Vnom** → Phase-Neutral or Phase-PE nominal voltage (110V,115V,120V,127V,133V,220V,230V,240V) to be used in the calculation of prospective short-circuit current **in LOOP/RCD measurement for L1, L2, L3, N three-phase systems (L-N-PE system) or the rated voltage between Phase-Phase in LOOP/RCD measurement for L1, L2, PE split-phase systems (L-L-PE system)**

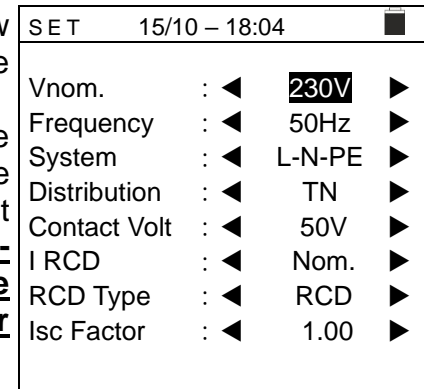

- **Frequency** → system frequency (50Hz, 60Hz)
- **System** → the type of connection in the RCD and LOOP functions (L-N-PE or L-L-PE)
- **Distribution** → the type of electric power supply system (TT, TN or IT)
- **Contact Volt** → limit of contact voltage (25V, 50V)
- **I RCD** → type of trip-out RCD current visualization (Real, Nom). With the “Nom” option, the instrument shows the normalized value of trip-out current (referred to the nominal current). **Example:** for RCD type A/F with  $I_{dn}=30mA$ , the actual value of normalized trip-out current can be up to **30mA**. With the “Real” option, the instrument shows the actual value of trip-out current by considering the coefficients indicated by guidelines IEC/EN61008 and IEC/EN61009 (1.414 for RCD type A/F, 1 for RCD type AC, 2 for RCD type B/B+). **Example:** for RCD type A/F with  $I_{dn}=30mA$ , the actual value of trip-out current can be up to **30mA \* 1.414 = 42mA**.
- **RCD Type** → the followed options are available:
  - **RCD** → the instrument performs the tripping time test with all multipliers in normal conditions
  - **RCCB** → **only for 30mA devices**, the instrument performs the tripping time test with x5 multipliers with a test current of 250mA (type AC) and 350mA (type A/F)
  - **RCDHiS** → the instrument performs the tripping time test with all multipliers in normal conditions and the “ $U_t$ ” or “ $R_{a\frac{1}{2}}$ ” measurements with test current  $I_{test} \cong 0.65 I_{\Delta N}/2$ . This option is used with high sensitivity RCDs
- **Isc Factor** → (**only for Norway**) possibility to select the value of the ISC factor (**0.01 ÷ 1.00**) to be used in the calculation of prospective short-circuit current.

Select the desired option by means of the arrow keys (**▲**,**▼**). To store settings, press the **ENTER** key, to quit without confirming the changes made, press the **ESC** key

### 5.1.4. General settings

Move the cursor to **General settings** by means of the arrow keys (▲,▼) and confirm with **ENTER**. Subsequently, the display shows the screen which allows adjust the display contrast, enabling/disabling the auto power off function, the sound of the function keys and the Auto Start (automatic start) function in the RCD and LOOP functions (see § 5.1.5).

Select the desired option by means of the arrow keys (▲,▼) and (◀, ▶). To store settings, press the **ENTER** key, to quit without confirming the changes made, press the **ESC** key

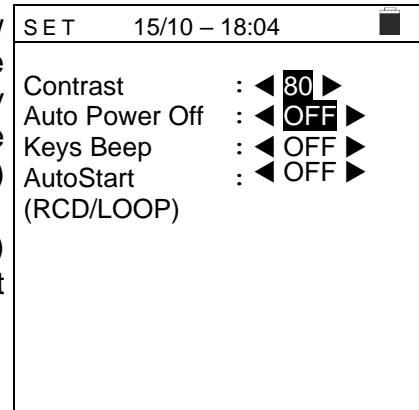

### 5.1.5. Auto Start feature

The AutoStart feature allows automatically performing the RCD and LOOP measurements. **In order to correctly use the AutoStart mode, it is NECESSARY to run the FIRST test by pressing the GO/STOP key on the instrument or the START key on the remote switch probe.**

After completing the first test, as soon as the instrument detects a steady input voltage within the allowed range, it runs the test automatically with no need to press the **GO/STOP** key on the instrument or the **START** key on the remote switch probe.

### 5.1.6. Date and time

Move the cursor to **Date and time** by means of the arrow keys (▲,▼) and confirm with **ENTER**. Subsequently, the display shows the screen which allows setting the system date/time. Select "Format" to set the European system ("DD/MM/YY, hh:mm" **EU** format) or the American system ("MM/DD/YY hh:mm" **USA** format).

Select the desired option by means of the arrow keys (▲,▼) and (◀, ▶). To store settings, press the **ENTER** key, to quit without confirming the changes made, press the **ESC** key.

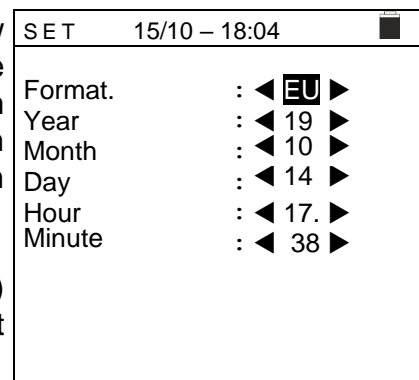

### 5.1.7. Information

Move the cursor to **Info** by means of the arrow keys (▲,▼) and confirm with **ENTER**. Subsequently, the display shows the initial screen as indicated in the screen to the side.

Press the **ESC** key to return to the main menu.

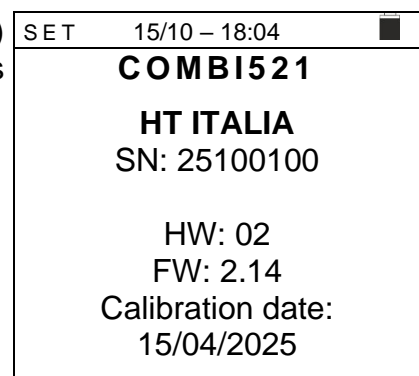

### 5.1.8. Operator name

This option allows to include the name of the operator who performs the measurements with the instrument (**max 12 characters**). This name will be included in the reports created using the management software.

1. Use the arrow keys ◀ or ▶ to move the cursor to the selected digit and press the **SAVE/ENTER** key to enter comment.
2. Move the cursor to “DEL” and press the **SAVE/ENTER** key to delete the selected digit.
3. Move the cursor to “END” and press the **SAVE/ENTER** key to confirm the written comment and go back to the previous screen.

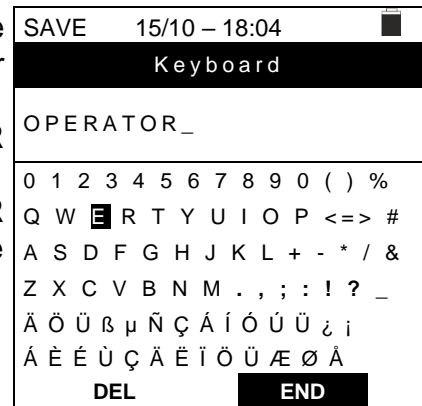

## 6. OPERATING INSTRUCTIONS

### 6.1. AUTO: AUTOMATIC TEST SEQUENCE (RA<sub>∓</sub>, RCD, MΩ)

This function allows performing the following measurements in an automatic sequence:

- Overall earth resistance without causing the RCD's tripping (RA<sub>∓</sub>)
- Tripping current and tripping time of **General** RCDs type A/F (Λ/∩/∩∩), AC (∩) or B/B+ (∩∩/∩∩∩)
- Insulation resistance with test voltages **50, 100, 250, 500, 1000VDC**



#### CAUTION

Some combinations of test parameters could be unavailable in compliance with the technical specifications of the instrument and the RCD tables (see § 10.1 – empty cells of RCD tables mean unavailable situations)



#### CAUTION

Testing the RCD's tripping time causes the RCD's tripping. **Therefore, check that there are NO users or loads connected downstream of the RCD being tested which could be damaged by a system downtime.** Disconnect all loads connected downstream of the RCD as they could produce leakage currents further to those produced by the instrument, thus invalidating the results of the test.

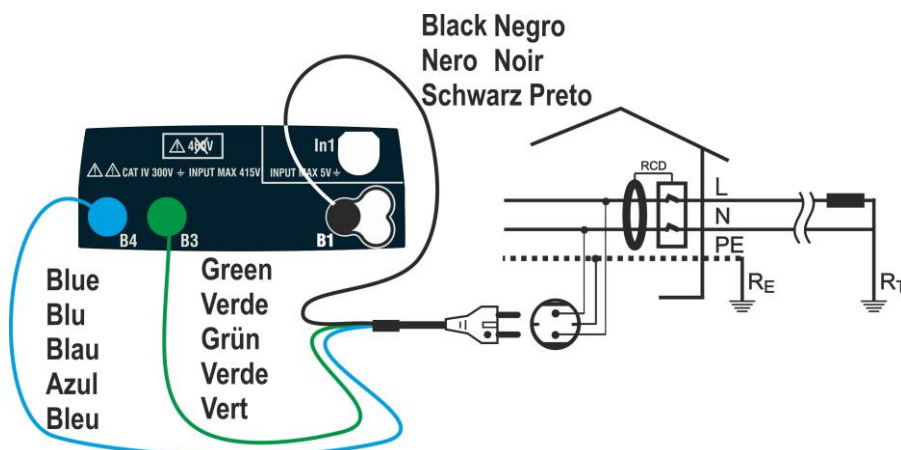

Fig. 4: Instrument connection in L-N-PE single phase system through mains plug

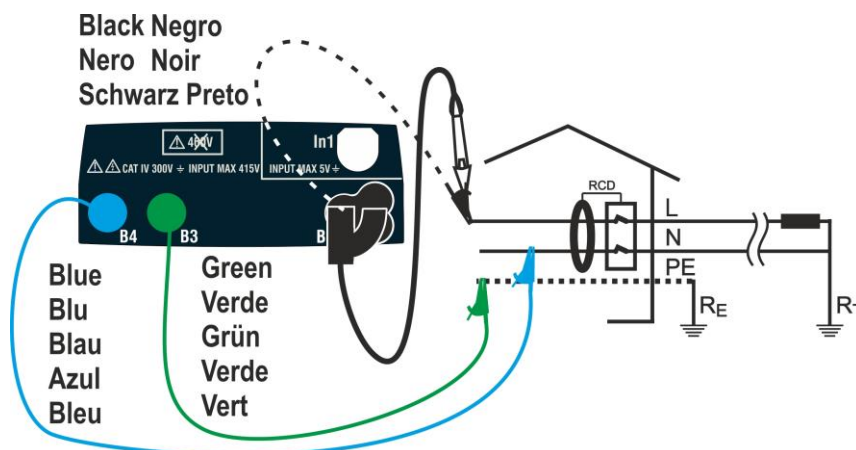

Fig. 5: Instrument connection in L-N-PE single phase system by means of single cables and remote switch probe

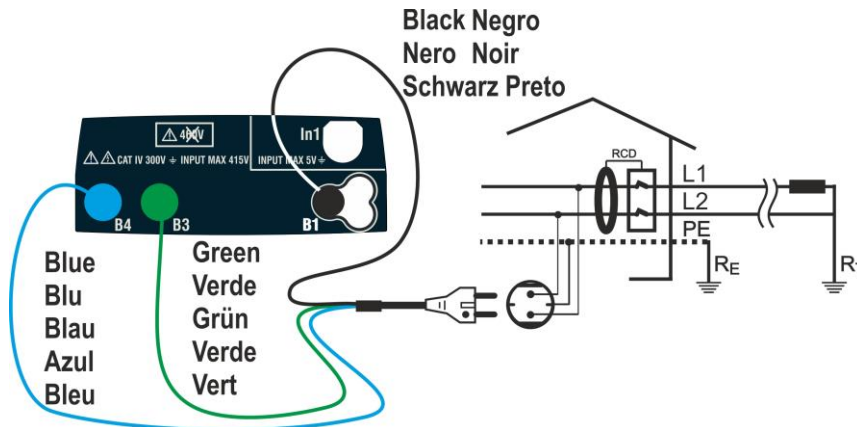

Fig. 6: Instrument connection in L-L-PE split phase system through mains plug

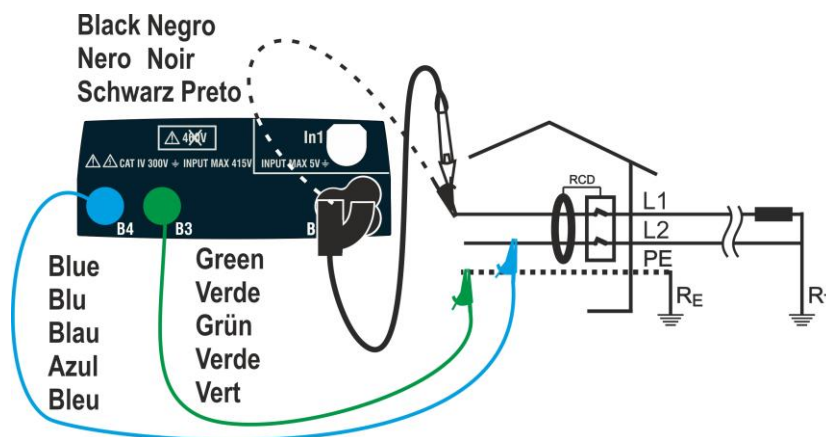

Fig. 7: Instrument connection in L-L-PE split phase system by means of single cables and remote switch probe

### TN systems

1. Press the **MENU** key, move the cursor to **AUTO** in the main menu by means of the arrow keys (**▲**, **▼**) and confirm with **ENTER**. Subsequently the instrument displays a screen similar to the one reported here to the side in case of **single-phase L-N-PE electrical system selected (see § 5.1.3). For split-phase L-L-PE systems the voltages indicated change in VL1-PE and VL1-L2**. Select the country (see § 5.1.2), the options “TN”, “25 or 50V”, “50Hz or 60Hz” and the reference voltage in the general settings of the instrument (see § 5.1.3).

AUTO	15/10 – 18:04		
TN	> ◂ ◃ <		
Isc=---	A	ZL-N=---	Ω
Ifc=---	A	ZL-PE=---	Ω
Trcd=---	ms	Ircd=---	mA
FREQ=0.00	Hz	Ut=---	V
VL-PE=0V		VL-N=0V	
30mA	~	500V	1.00MΩ
IΔn	Type	Vtest	Lim

2. Use the **◀**, **▶** keys to select the parameter to be modified, and the **▲**, **▼** keys to modify the parameter value:
  - **IΔn** → The virtual key allows setting the nominal value of the RCD’s tripping current, which may be: **6mA, 10mA, 30mA**.
  - **Type** → The virtual key enables the selection of the RCD type, which may be: **A/F** (⌚/⌚), **AC** (⌚) or **B/B+** (⌚/⌚+)
  - **Vtest** → This key allows selecting the DC test voltage generated during measurement. The following values are available: **50V, 100V, 250V, 500V, 1000V**.
  - **Lim** → This key allows the selection of the minimum limit threshold in order to consider the insulation measurement correct. The following values are available: **0.05MΩ, 0.10MΩ, 0.23MΩ, 0.25MΩ, 0.50MΩ, 1.00MΩ, 100MΩ**.

**CAUTION**



- Make sure to select the correct value when setting the RCD's test current. If setting a current higher than the nominal current of the device being tested, the RCD would be tested at a current higher than the correct one, thus facilitating a faster tripping of the switch.
- The “▶◊◀” symbol indicates that the test cables or the plug cable have already been calibrated in the LOOP section (see § 6.7.2). The AUTO function takes this value as a reference.

3. Insert the green, blue and black connectors of the three-pin plug cable into the corresponding inputs B1, B3 and B4 of the instrument. As an alternative, use the single cables and apply the relevant alligator clips to the free ends of the cables. It is also possible to use the remote switch probe by inserting its multipolar connector into the input B1. Connect the plug, the alligator clips or the remote switch probe to the electrical mains according to Fig. 4, Fig. 5, Fig. 6 or Fig. 7

4. Note the correct voltage values between L-N and L-PE as shown in the screen to the side.

AUTO		15/10 – 18:04	
TN		▶◊◀	
Isc=---	A	ZL-N=---	Ω
Ifc=---	A	ZL-PE=---	Ω
Trcd=---		ms Ircd=---	
FREQ=50.00		Hz Ut=---	
VL-PE=231V		VL-N=232V	
30mA	~	500V	1.00MΩ
IΔn	Type	Vtest	Lim

5. Press the **GO/STOP** key on the instrument or the **START** key on the remote switch probe. The instrument will start the automatic test sequence.

**CAUTION**



If message “**Measuring...**” appears on the display, the instrument is performing measurement. During this whole stage, do not disconnect the test leads of the instrument from the mains.

6. The **Ra<sub>T</sub>** test starts and the screen to the side appears on the display. After **approx. 20s**, the **Ra<sub>T</sub>** ends and the values of **Z<sub>L-N</sub>**, **Z<sub>L-PE</sub>**, **I<sub>SCMin</sub>**, **I<sub>FCMin</sub>** immediately appear on the display.  
 In case of a **positive** result of all the tests sequentially performed as **Ra<sub>T</sub>** (**Z<sub>L-N</sub>** and **Z<sub>L-PE</sub>** < **199Ω**), the instrument goes on with the test on the trip-out current and trip-out time of the RCD.

AUTO		15/10 – 18:04	
TN		▶◊◀	
Isc=1437A	ZL-N=	0.16Ω	
Ifc=1277A	ZL-PE=	0.18Ω	
Trcd=---		ms Ircd=---	
FREQ=50.00		Hz Ut=---	
VL-PE=231V		VL-N=232V	
<b>Measuring...</b>			
30mA	~	500V	1.00MΩ
IΔn	Type	Vtest	Lim

7. The **RCD** test starts and the screen to the side appears on the display. The trip-out current and the trip-out time values appear on the display.  
 In case of a **positive** result of all the tests sequentially performed during the RCD test (**Trcd** and **Ircd** parameters) (see § 12.4), the instrument goes on with the test on insulation resistance between L-N, L-PE and N-PE conductors.

AUTO		15/10 – 18:04		
TN		>φ<		
Isc=1437A ZL-N= 0.16Ω				
Ifc=1277A ZL-PE=0.18Ω				
Trcd=25ms Ircd=27.0mA				
FREQ=50.00Hz Ut=1.5V				
VL-PE=231V VL-N=232V				
<b>Measuring...</b>				
30mA		500V	1.00MΩ	
IΔn	Type	Vtest	Lim	

8. The insulation test starts and the screen to the side appears on the display. The RL-N, RL-PE and RN-PE values appear on the display.  
 In case of a **positive** result of all the tests sequentially performed during the insulation test (insulation resistance > minimum limit threshold), the instrument has completed its tasks, shows the “OK” message and displays the screen to the side.

AUTO		15/10 – 18:04		
TN		>φ<		
RL-N	>999MΩ	Vt=	523V	
RL-PE	>999MΩ	Vt=	524V	
RN-PE	>999MΩ	Vt=	522V	
FREQ=50.00Hz Ut=1.5V				
VL-PE=0V VL-N=0V				
<b>◀ OK ▶</b>				
30mA		500V	1.00MΩ	
IΔn	Type	Vtest	Lim	

Press (◀, ▶) in order to display the values of the second available page.

9. In case of a **negative** result of the **Ra<sub>T</sub>** test (**Z<sub>L-N</sub>** and/or **Z<sub>L-PE</sub> >199Ω**), the auto test is automatically blocked, the message “NOT OK” is shown and the screen to the side is displayed.

AUTO		15/10 – 18:04		
TN		>φ<		
Isc=1437A ZL-N= 0.16Ω				
Ifc=---A ZL-PE >199Ω				
Trcd=---ms Ircd=---mA				
FREQ=50.00Hz Ut=---V				
VL-PE=231V VL-N=232V				
<b>◀ NOT OK ▶...</b>				
30mA		500V	1.00MΩ	
IΔn	Type	Vtest	Lim	

10. In case of a **negative** result of the **RCD test** (**Trcd >300ms** or **Ircd > 33.0mA**), the auto test is automatically blocked, the message “NOT OK” is shown and the screen to the side is displayed.

AUTO		15/10 – 18:04		
TN		>φ<		
Isc=1437A ZL-N= 0.16Ω				
Ifc=1277A ZL-PE=0.18Ω				
Trcd=>300ms Ircd >33.0mA				
FREQ=50.00Hz Ut=1.5V				
VL-N=232V VL-PE=231V				
<b>◀ NOT OK ▶</b>				
30mA		500V	1.00MΩ	
IΔn	Type	Vtest	Lim	

11. In case of a **negative** result of the **Insulation test** (insulation resistance < minimum limit threshold), the auto test is automatically blocked, the message “NOT OK” is shown and the screen to the side is displayed.

AUTO		15/10 – 18:04	
TN		>φ<	
RL-N	>999MΩ	Vt=	523V
RL-PE	=0.03MΩ	Vt=	57V
RN-PE	>999MΩ	Vt=	522V
FREQ	=50.00Hz	Ut=	1.5V
VL-PE	=0V	VL-N	=0V
<b>◀ NOT OK ▶</b>			
30mA		500V	1.00MΩ
IΔn	Type	Vtest	Lim

12. Press the **SAVE** key to store the test result in the instrument’s memory (see § 7.1) or the **ESC/MENU** key to exit the screen without saving and go back to the main measuring screen.

### TT systems

1. Press the **MENU** key, move the cursor to **AUTO** in the main menu by means of the arrow keys (▲,▼) and confirm with **ENTER**. Subsequently, the instrument displays a screen similar to the one reported here to the side **in case of single-phase L-N-PE electrical system selected (see § 5.1.3). For split-phase L-L-PE systems the voltages indicated change in VL1-PE and VL1-L2**. Select the country (see § 5.1.2), the options “TT”, “25 or 50V”, “50Hz or 60Hz” and the reference voltage in the general settings of the instrument (see § 5.1.3)

AUTO		15/10 – 18:04	
TT		>φ<	
RA=---	Ω	Ut=---	V
Trcd=---	ms	Ircd=---	mA
FREQ=	0.00Hz	VL-PE=	0V
		VL-N=	0V
30mA		500V	1.00MΩ
IΔn	Type	Vtest	Lim

2. Use the ◀, ▶ keys to select the parameter to be modified, and the ▲, ▼ keys to modify the parameter value.
- **IΔn** → The virtual key allows setting the nominal value of the RCD’s tripping current, which may be: **6mA, 10mA, 30mA**.
  - **Type** → The virtual key enables the selection of the RCD type, which may be: **A/F** () or **B/B+** ()
  - **Vtest** → This key allows selecting the DC test voltage generated during measurement. The following values are available: **50V, 100V, 250V, 500V, 1000V**.
  - **Lim** → This key allows the selection of the minimum limit threshold in order to consider the insulation measurement correct. The following values are available: **0.05MΩ, 0.10MΩ, 0.23MΩ, 0.25MΩ, 0.50MΩ, 1.00MΩ, 100MΩ**.

### CAUTION



- Make sure to select the correct value when setting the RCD’s test current. If setting a current higher than the nominal current of the device being tested, the RCD would be tested at a current higher than the correct one, thus facilitating a faster tripping of the switch.
- The “▶∅◀” symbol indicates that the test cables or the plug cable has already been calibrated in the LOOP section (see § 6.7). The AUTO function takes this value as a reference.

- Insert the green, blue and black connectors of the three-pin plug cable into the corresponding inputs B1, B3 and B4 of the instrument. As an alternative, use the single cables and apply the relevant alligator clips to the free ends of the cables. It is also possible to use the remote switch probe by inserting its multipolar connector into the input B1. Connect the plug, the alligator clips or the remote switch probe to the electrical mains according to Fig. 4, Fig. 5, Fig. 6 or Fig. 7

- Note the correct voltage values between L-N and L-PE as shown in the screen to the side.

AUTO		15/10 – 18:04	
TT		>φ<	
RA=---	Ω	Ut=---	V
Trcd=---		Ircd=---	
FREQ=50.00Hz		Ut=---	
VL-PE=231V		VL-N=232V	
30mA		500V	1.00MΩ
IΔn	Type	Vtest	Lim

- Press the **GO/STOP** key on the instrument or the **START** key on the remote switch probe. The instrument will start the automatic test sequence.

### CAUTION



If message “**Measuring...**” appears on the display, the instrument is performing measurement. During this whole stage, do not disconnect the test leads of the instrument from the mains.

- The **Ra<sub>T</sub>** test starts and the screen to the side appears on the display. After **approx. 20s**, the **Ra<sub>T</sub>** ends and the values of **RA** (overall earth resistance) and **Ut** (contact voltage) immediately appear on the display. In case of a **positive** result of the **Ra<sub>T</sub>** test (see § 12.8), the instrument goes on with the test on the trip-out current and trip-out time of the RCD.

AUTO		15/10 – 18:04	
TT		>φ<	
RA=48.8	Ω	Ut=1.5	V
Trcd=---		Ircd=---	
FREQ=50.00Hz		Ut=---	
VL-PE=231V		VL-N=232V	
<b>Measuring...</b>			
30mA		500V	1.00MΩ
IΔn	Type	Vtest	Lim

- The **RCD** test starts and the screen to the side appears on the display. The trip-out current and the trip-out time values appear on the display. In case of a **positive** result of all the tests sequentially performed during RCD test (**Trcd** and **Ircd** parameters) (see § 12.4), the instrument goes on with the test on insulation resistance between L-N, L-PE and N-PE conductors.

AUTO		15/10 – 18:04	
TT		>φ<	
RA=48.8	Ω	Ut=1.5	V
Trcd=25ms		Ircd=27.0mA	
FREQ=50.00Hz		Ut=---	
VL-PE=231V		VL-N=232V	
<b>Measuring...</b>			
30mA		500V	1.00MΩ
IΔn	Type	Vtest	Lim

8. The insulation test starts and the screen to the side appears on the display. The RL-N, RL-PE and RN-PE values appear on the display. In case of a **positive** result of all the test sequentially performed during insulation test (insulation resistance > minimum limit threshold), the instrument has completed its tasks, shows the “OK” message and displays the screen to the side.

Press (◀, ▶) in order to display the values of the second available page.

AUTO		15/10 – 18:04		■	
TT				▶◀	
RL-N	>999MΩ	Vt=	523V		
RL-PE	>999MΩ	Vt=	524V		
RN-PE	>999MΩ	Vt=	522V		
FREQ=50.00Hz					
VL-PE=0V		VL-N=0V			
◀ OK ▶					
30mA		500V	1.00MΩ		
IΔn	Type	Vtest	Lim		

9. In case of a **negative** result of the  $R_{a\frac{1}{2}}$  test (see § 12.8), the auto test is automatically blocked, the message “NOT OK” is shown and the screen to the side is displayed.

AUTO		15/10 – 18:04		■	
TT				▶◀	
RA=	1824 Ω	Ut=	54.7 V		
Trcd=	---ms	Ircd=	---mA		
FREQ=50.00Hz					
VL-PE=	231V	VL-N=	232V		
◀ NOT OK ▶...					
30mA		500V	1.00MΩ		
IΔn	Type	Vtest	Lim		

10. In case of a **negative** result of the **RCD test (Trcd >300ms or Ircd > 33.0mA)**, the auto test is automatically blocked, the message “NOT OK” is shown and the screen to the side is displayed.

AUTO		15/10 – 18:04		■	
TT				▶◀	
RA=	48.8 Ω	Ut=	1.5 V		
Trcd=>	300ms	Ircd >	33.0mA		
FREQ=50.00Hz					
VL-PE=	231V	VL-N=	232V		
◀ NOT OK ▶					
30mA		500V	1.00MΩ		
IΔn	Type	Vtest	Lim		

11. In case of a **negative** result of the **Insulation test** (insulation resistance < minimum limit threshold), the auto test is automatically blocked, the message “NOT OK” is shown and the screen to the side is displayed.

AUTO		15/10 – 18:04		■	
TT				▶◀	
RL-N	>999MΩ	Vt=	523V		
RL-PE=	0.03MΩ	Vt=	57V		
RN-PE	>999MΩ	Vt=	522V		
FREQ=50.00Hz		Ut=	1.5V		
VL-PE=0V		VL-N=0V			
◀ NOT OK ▶					
30mA		500V	1.00MΩ		
IΔn	Type	Vtest	Lim		

12. Press the **SAVE** key to store the test result in the instrument’s memory (see § 7.1) or the **ESC/MENU** key to exit the screen without saving and go back to the main measuring screen.

### 6.1.1. Anomalous situations

1. If the instrument detects a L-N or L-PE voltage higher than the maximum limit (265V), it does not carry out the test and displays a screen like the one to the side. Check the connection of measuring cables.

AUTO	15/10 – 18:04		
TN			
Isc=---	A	ZL-N=---	Ω
Ifc=---	A	ZL-PE=---	Ω
Trcd=---ms Ircd=---mA			
FREQ=50.00Hz Ut=---V			
VL-PE=270V VL-N=272V			
<b>Voltage &gt; 265V</b>			
30mA		500V	1.00MΩ
IΔn	Type	Vtest	Lim

2. If the instrument detects a L-N or L-PE voltage lower than the minimum limit (100V), it does not carry out the test and displays a screen like the one to the side. Check that the system being tested is supplied.

AUTO	15/10 – 18:04		
TN			
Isc=---	A	ZL-N=---	Ω
Ifc=---	A	ZL-PE=---	Ω
Trcd=---ms Ircd=---mA			
FREQ=50.00Hz Ut=---V			
VL-PE=15V VL-N=15V			
<b>Voltage &lt; 100V</b>			
30mA		500V	1.00MΩ
IΔn	Type	Vtest	Lim

3. If the instrument detects that the phase and neutral leads are inverted, it does not carry out the test and a screen similar to the one reported to the side is displayed. Rotate the mains plug or check the connection of the measuring cables.

AUTO	15/10 – 18:04		
TN			
Isc=---	A	ZL-N=---	Ω
Ifc=---	A	ZL-PE=---	Ω
Trcd=---ms Ircd=---mA			
FREQ=--- Hz Ut=---V			
VL-PE=--- V VL-N=--- V			
<b>Exchange L-N</b>			
30mA		500V	1.00MΩ
IΔn	Type	Vtest	Lim

4. If the instrument detects a dangerous voltage on PE conductor, it does not carry out the test and displays a screen like the one to the side.

AUTO	15/10 – 18:04		
TN			
Isc=---	A	ZL-N=---	Ω
Ifc=---	A	ZL-PE=---	Ω
Trcd=---ms Ircd=---mA			
FREQ=--- Hz Ut=---V			
VL-PE=--- V VL-N=--- V			
<b>Voltage on PE</b>			
30mA		500V	1.00MΩ
IΔn	Type	Vtest	Lim

## 6.2. DMM: DIGITAL MULTIMETER FUNCTION

This function allows reading the real time TRMS values of P-N Voltage, P-PE Voltage, N-PE Voltage and Frequency (@ P-N inputs) when the instrument is connected to an installation.

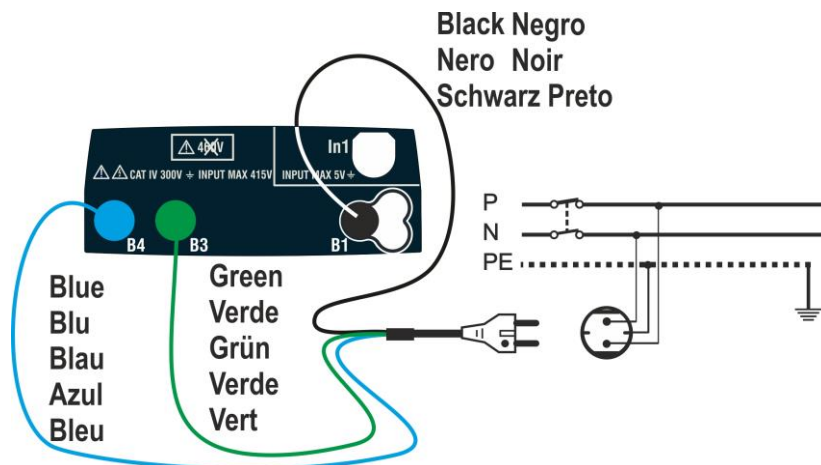

Fig. 8: Instrument connection through mains plug

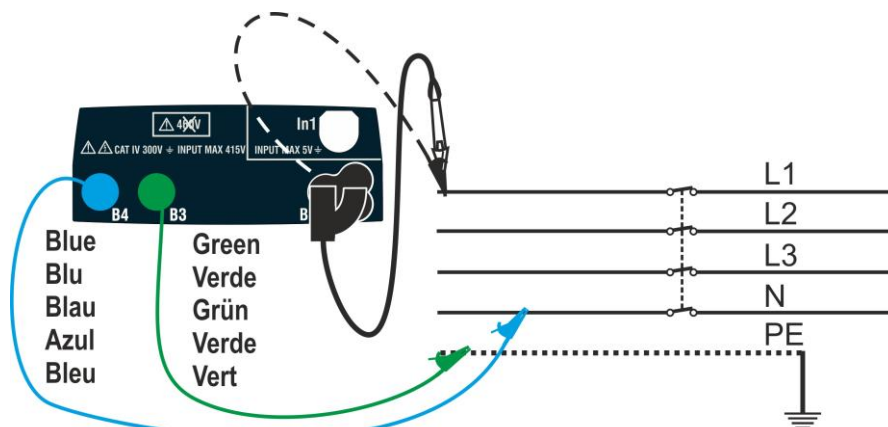

Fig. 9: Instrument connection by means of single cables and remote switch probe

1. Press the **MENU** key, move the cursor to **DMM** in the main menu by means of the arrow keys (**▲**, **▼**) and confirm with **ENTER**. Subsequently, the instrument displays a screen similar to the one reported here to the side.

DMM		15/10 – 18:04		■	
FREQ.	=	0.00	Hz		
VL-N	=	0	V		
VL-PE	=	0	V		
VN-PE	=	0	V		

2. Insert the green, blue and black connectors of the three-pin plug cable into the corresponding inputs B1, B3 and B4 of the instrument. As an alternative, use the single cables and apply the relevant alligator clips to the free ends of the cables. It is also possible to use the remote switch probe by inserting its multipolar connector into the input B1. Connect the plug, the alligator clips or the remote switch probe to the electrical mains according to Fig. 8 or Fig. 9.

3. The TRMS values of L-N voltage, L-PE voltage, N-PE voltage and the frequency of L-N voltage are shown on the display.

Press the **GO/STOP** key to enable/disable the “HOLD” function in order to fix the value on the display.

DMM	15/10 – 18:04	
FREQ.	= 50.00	Hz
VL-N	= 230	V
VL-PE	= 230	V
VN-PE	= 2	V
<b>HOLD</b>		

### CAUTION



These data cannot be saved in the instrument's internal memory.

### 6.3. RPE: CONTINUITY OF PROTECTIVE CONDUCTORS

This function is performed in compliance with standards IEC/EN61557-4, BS7671 17th/18th edition and allows measuring the resistance of protective and equipotential conductors.



#### CAUTION

- The instrument can be used for measurements on installations with overvoltage category CAT IV 300V to earth and max 415V between inputs.
- We recommend holding the alligator clip respecting the safety area created by the hand protection (see § 4.2).
- Check that no voltage is present at the ends of the item to be tested before carrying out a continuity test.  
The results may be influenced by the presence of auxiliary circuits connected in parallel with the item to be tested or by transient currents.

The following operating modes are available:

- **STD** The test is activated by pressing the **GO/STOP** key (or **START** on the remote switch probe). Recommended mode
- **TMR** The user can set a sufficiently long time to be able to move the tip on the conductors being examined while the instrument performs the test. For the whole duration of measurement, the instrument emits a short acoustic signal every 3 seconds. The user shall touch the metal part under test while the instrument beeps. If, during measurement, a result takes a value higher than the set limit, the instrument emits a continuous acoustic signal. To stop the test, press the **GO/STOP** key or the **START** key on the remote switch probe again.
- **>φ<** Compensation of the resistance of the cables used for measurement. The instrument automatically subtracts the value of cable resistance from the measured resistance value. **Therefore, it is necessary that this value is measured (by the >φ< function) each time the measuring cables are changed or extended.**



#### CAUTION

Continuity test is carried out by supplying a current higher than 200mA in case the resistance does not exceed ca. 5Ω (including resistance of the test cables). For higher resistance values, the instrument carries out the test with a current lower than 200mA.

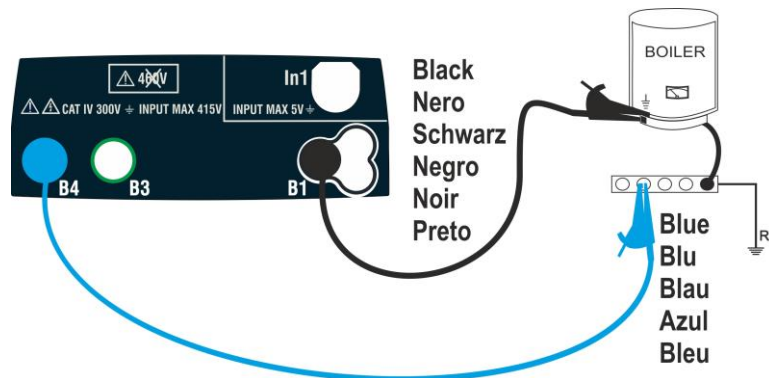

Fig. 10: Continuity test by means of single cables

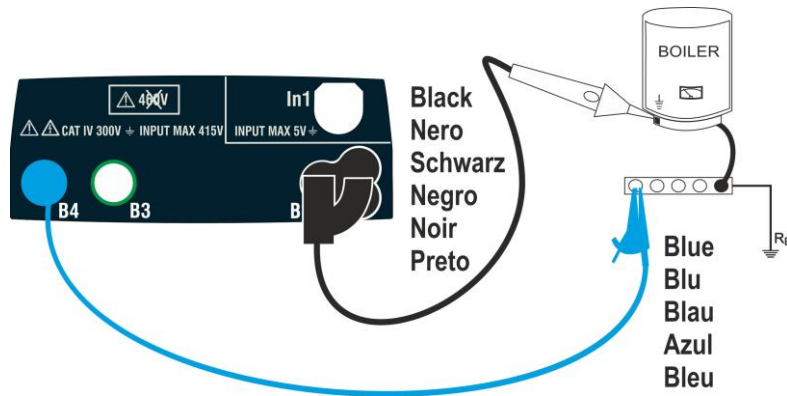

Fig. 11: Continuity test by means of remote switch probe

1. Press the **MENU** key, move the cursor to **RPE** in the main menu by means of the arrow keys (**▲**, **▼**) and confirm with **ENTER**. Subsequently, the instrument displays a screen similar to the one reported here to the side.

RPE	15/10 – 18:04		
R	=	- - -	Ω
Itest	=	- - -	mA
STD	2.00Ω	- - -	Ω
MODE	Lim		>φ<

2. Use the **◀**, **▶** keys to select the parameter to be modified, and the **▲**, **▼** keys to modify the parameter value:
  - **MODE** → this virtual key allows setting the test mode. The following options are available: **STD**, **TMR**.
  - **Lim** → this virtual key allows the selection of the maximum limit to consider the measured value correct. It is possible to set a limit included in the range: **0.01Ω ÷ 9.99Ω** in steps of 0.01Ω.
  - **Time (TMR mode)** → this virtual key allows you to set the duration of the measurement in the range: **3s ÷ 99s** in steps of 3s.
3. Insert the blue and black connectors of the single cables into the corresponding inputs B4 and B1 of the instrument. Apply the relevant alligator clips to the free ends of the cables. It is also possible to use the remote switch probe by inserting its multipolar connector into the input B1.
4. Should the length of the cables provided be insufficient for the measurement to be performed, extend the blue cable.
5. Select the **>φ<** mode to compensate the resistance of the cables used for measuring according to the instructions given in 6.3.2.

**CAUTION**



Before connecting the test leads, make sure that there is no voltage at the ends of the conductor to be tested.

6. Connect the test leads to the ends of the conductor to be tested as shown in Fig. 10 or Fig. 11.

**CAUTION**



Always make sure, before any test, that the compensation resistance value of the cables is referred to the cables currently used. In case of doubt, repeat the cable calibration procedure as indicated in § 6.3.2.

- Press the **GO/STOP** key on the instrument or the **START** key on the remote switch probe. The instrument will start the measurement.

**CAUTION**



If message "**Measuring...**" appears on the display, the instrument is performing measurement. During this whole stage, do not disconnect the test leads of the instrument from the conductor under test.

- At the end of measurement, the instrument shows on the display the message "OK" in case of a positive result (value lower than the set limit threshold) or "NOT OK" in case of a negative result (value higher than the set limit threshold).

RPE	15/10 – 18:04		
R	=	0.22	Ω
I <sub>test</sub>	=	212	mA
<b>OK</b>			
STD	2.00Ω		0.21 Ω
MODE	Lim		> φ <

**6.3.1. TMR mode**

- With the arrow keys (▲, ▼) select the "TMR" option in the "**Mode**" section. The instrument displays a screen like the one shown to the side. Set the measurement duration in the "**Time**" section and follow the steps from point 2 to point 6 of § 6.2.

RPE	15/10 – 18:04		
R	=	- - -	Ω
I <sub>test</sub>	=	- - -	mA
T	=	- - -	s
TMR	2.00Ω	12s	- - - Ω
MODE	Lim	Time	> φ <

- Press the **GO/STOP** key on the instrument or the **START** key on the remote switch probe. The instrument starts a series of continuous measurements for the entire duration set with a countdown, giving a short beep every 3 seconds and alternating the words "**Measuring...**" and "**Please wait...**".

RPE	15/10 – 18:04		
R	=	0.23	Ω
I <sub>test</sub>	=	209	mA
T	=	11	s
<b>Please wait...</b>			
TMR	2.00Ω	12s	0.01 Ω
MODE	Lim	Time	> φ <

- At the end of the set duration time, the instrument shows on the display the maximum value among all the partial measurements performed and the message "OK" in case of a positive result (value lower than the set limit threshold) or "NOT OK" in case of a negative result (value higher than the set limit threshold).

RPE	15/10 – 18:04		
R	=	0.54	Ω
I <sub>test</sub>	=	209	mA
T	=	0	s
<b>OK</b>			
TMR	2.00Ω	12s	0.01 Ω
MODE	Lim	Time	> φ <

- Press the **SAVE** key to store the test result in the instrument's memory (see § 7.1) or the **ESC/MENU** key to exit the screen without saving and go back to the main measuring screen

### 6.3.2. > φ < mode

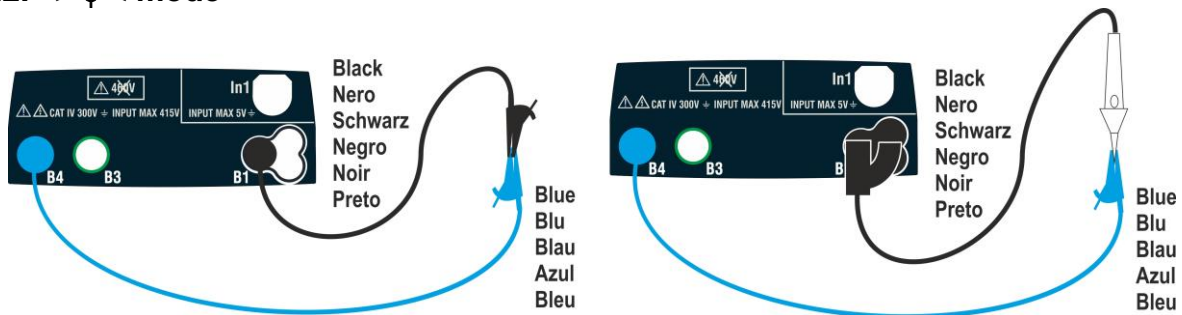

Fig. 12: Compensation of single cables and remote switch probe resistance

- Use the ◀, ▶ keys to select the the virtual key > φ <
- Connect the alligator clips and/or test leads and/or remote switch probe to the conductor to be tested as indicated in Fig. 12
- Press the **GO/STOP** key on the instrument or the **START** key on the remote switch probe. The instrument starts the calibration procedure of the cables, immediately followed by the verification of the compensated value.

### CAUTION



If message "**Measuring...**" appears on the display, the instrument is performing measurement. If message "**Verify**" appears on the display, the instrument is verifying the calibrated value. During this whole stage, do not unshort the test leads of the instrument.

- Once calibration is completed, in case the detected value is lower than 5Ω, the instrument gives a double acoustic signal which indicates the positive result of the test and displays a screen similar to the one reported here to the side.

RPE	15/10 – 18:04		
R	=	- - -	Ω
I <sub>test</sub>	=	- - -	mA
STD	2.00Ω		0.01 Ω
MODE	Lim		> φ <

- In order to delete the compensation resistance value of the cables, it is necessary to perform a cable calibration procedure with a resistance higher than 5Ω at test leads (e.g. with open test leads).

### 6.3.3. Anomalous situations

1. In case the detected value is higher than the set limit, the instrument gives a long acoustic signal and displays a screen similar to the one reported here to the side.

RPE	15/10 – 18:04		
R	=	4.54 $\Omega$	
Itest	=	212 mA	
<b>NOT OK</b>			
STD	2.00 $\Omega$	0.01 $\Omega$	
MODE	Lim		> $\phi$ <

2. If the instrument detects a resistance higher than the full scale, it emits a prolonged acoustic signal and displays a screen like the one to the side.

RPE	15/10 – 18:04		
R	=	>1999 $\Omega$	
Itest	=	- - - mA	
<b>NOT OK</b>			
STD	2.00 $\Omega$	0.01 $\Omega$	
MODE	Lim		> $\phi$ <

3. When using the > $\phi$ < mode, in case the instrument detects a calibration reset (performing the operation with open terminals), the instrument gives out a long sound and displays a screen like the one to the side.

RPE	15/10 – 18:04		
R	=	- - - $\Omega$	
Itest	=	- - - mA	
<b>Zero Reset</b>			
STD	2.00 $\Omega$	- - - $\Omega$	
MODE	Lim		> $\phi$ <

4. When using the > $\phi$ < mode, in case the instrument detects a resistance higher than 5 $\Omega$  at its terminals, it emits a prolonged acoustic signal, resets the compensated value and displays a screen like the one to the side.

RPE	15/10 – 18:04		
R	=	- - - $\Omega$	
Itest	=	- - - mA	
<b>Calib. not OK</b>			
STD	2.00 $\Omega$	- - - $\Omega$	
MODE	Lim		> $\phi$ <

5. If the instrument detects a voltage higher than 3V at its terminals, it does not perform the test, emits a prolonged acoustic signal and displays a screen like the one to the side.

RPE	15/10 – 18:04		
R	=	- - - $\Omega$	
Itest	=	- - - mA	
<b>Vin &gt; 3V</b>			
STD	2.00 $\Omega$	- - - $\Omega$	
MODE	Lim		> $\phi$ <

### 6.4. LOΩ: CONTINUITY OF PROTECTIVE CONDUCTORS WITH 10A

This function allows measuring the resistance of protective and equipotential conductors with a test current >10A by using the optional accessory **EQUITEST** connected to the instrument through the C2050 cable. The accessory must be directly powered by the mains on which measurements are performed. For detailed information, please refer to the user manual of the EQUITEST accessory



#### CAUTION

- The instrument can be used for measurements on installations with overvoltage category CAT IV 300V to earth and max 415V between inputs.
- We recommend holding the alligator clip respecting the safety area created by the hand protection (see § 4.2).
- Check that no voltage is present at the ends of the item to be tested before carrying out a continuity test.  
The results may be influenced by the presence of auxiliary circuits connected in parallel with the item to be tested or by transient currents.
- Continuity test is carried out by supplying a current **higher than 10A** in case the resistance does not exceed ca. 0.7Ω (including resistance of the test cables). **The 4-wire method allows extending the test leads without any preliminary calibration.**

1. Press the **MENU** key, move the cursor to **LoΩ** in the main menu by means of the arrow keys (▲, ▼) and confirm with **ENTER**. Subsequently, the instrument displays a screen similar to the one reported here to the side.

LoΩ	15/10 – 18:04	■
R	= - - - Ω	
I <sub>test</sub>	= - - - A	
0.500 Ω		MAN
Lim.	INFO	MODE

2. Use the ◀, ▶ keys to select the parameter to be modified, and the ▲, ▼ keys to modify the value of parameters:
  - **Lim** → this virtual key allows the selection of the maximum limit to consider the measured value correct. It is possible to set a limit included in the range: **0.003Ω ÷ 0.500Ω** in steps of 0.001Ω
  - **MODE** → The virtual key allows the setting of the measurement modes. The following options are possible: **MAN** (the measurement is activated manually by using the **GO/STOP** key), **AUTO** (the measurement is automatically started after connecting the EQUITEST accessory to the cable under test without pressing the **GO/STOP** key)

3. Connect the EQUITEST accessory to the mains (230/240V – 50/60Hz) and check that the green LED lights up. Connect the accessory to the instrument through the C2050 cable. Subsequently, the “Conn.” message is shown indicating the correct detection by the instrument.

LoΩ	15/10 – 18:04		
R	=	- - - Ω	
Itest	=	- - - A	
0.500 Ω Conn. MAN			
Lim.	INFO	MODE	

4. Use the ◀, ▶ keys to select the “INFO” item. The screen to the side is shown on the display indicating the information relevant to the EQUITEST accessory.

LoΩ	15/10 – 18:04		
EQUITEST			
SN:	210600023		
FW:	1.00		
HW:	1.00		
CalDate:	30/11/21		
Status:	Connected		
0.500 Ω Conn. MAN			
Lim.	INFO	MODE	

5. Connect the alligator clips to the conductor to be tested (see the user manual of EQUITEST accessory for each details)

6. Press the **GO/STOP** key on the instrument. The instrument will start the measurement (in case of MAN mode selection) or perform automatic measurement (in case of AUTO mode selection). At the end of measurement, the instrument shows on the display the message "OK" in case of a positive result (value lower than the set limit threshold) or "NOT OK" in case of a negative result (value higher than the set limit threshold).

LoΩ	15/10 – 18:04		
R	=	0.328 Ω	
Itest	=	14.76 A	
OK			
0.500 Ω Conn. MAN			
Lim.	INFO	MODE	

7. Press the **SAVE** key to store the test result in the instrument’s memory (see § 7.1) or the **ESC/MENU** key to exit the screen without saving and go back to the main measuring screen.

### 6.4.1. Anomalous situations

1. If the instrument detects a voltage higher than 3V at its terminals, it does not perform the test, it emits a prolonged acoustic signal and displays a screen like the one to the side.

LoΩ		15/10 – 18:04			
R	=	- - - Ω			
Itest	=	- - - A			
<b>Vin &gt; 3V</b>					
0.500 Ω		Conn.	MAN		
Lim.	INFO	MODE			

2. If the instrument does not detect the EQUITEST accessory, it displays a screen like the one to the side. Check the connections with the accessory.

LoΩ		15/10 – 18:04			
R	=	- - - Ω			
Itest	=	- - - A			
<b>Accessory not detected</b>					
0.500 Ω		Conn.	MAN		
Lim.	INFO	MODE			

3. The instrument shows on the display the message "**NOT OK**" in case of a positive result (value lower than the set limit threshold) but with test current lower than 10A, as indicated in the screen like the one to the side.

LoΩ		15/10 – 18:04			
R	=	0.119 Ω			
Itest	=	8.05 A			
<b>NOT OK</b>					
0.500Ω		Conn.	MAN		
Lim.	INFO	MODE			

### 6.5. MΩ: MEASUREMENT OF INSULATION RESISTANCE

This function is performed in compliance with standards IEC/EN61557-2, BS7671 17th/18th edition and allows measuring the insulation resistance between the active conductors and between each active conductor and the earth. The following operating modes are available:

- **MAN** the test can be carried out between the L-N, L-PE or N-PE conductors and has a fixed duration of 3s when the **GO/STOP** key is pressed on the instrument (or **START** on the remote switch probe). Recommended mode
- **TMR** the test is carried out between the L-PE conductors and has a programmable duration in the range **3s ÷ 999s** in steps of 1s by pressing the **GO/STOP** key on the instrument (or **START** of the remote switch probe). It is possible to perform **DAR** (Dielectric Absorbtion Ratio) duration test for test time >60s and **PI** (Polarization Index) for test time > 600s (10min) (see § 12.2.1 and § 12.2.2)
- **AUTO** the instrument performs an automatic sequence test between the L-N, L-PE and N-PE conductors when the **GO/STOP** key is pressed on the instrument (or **START** of the remote switch probe).

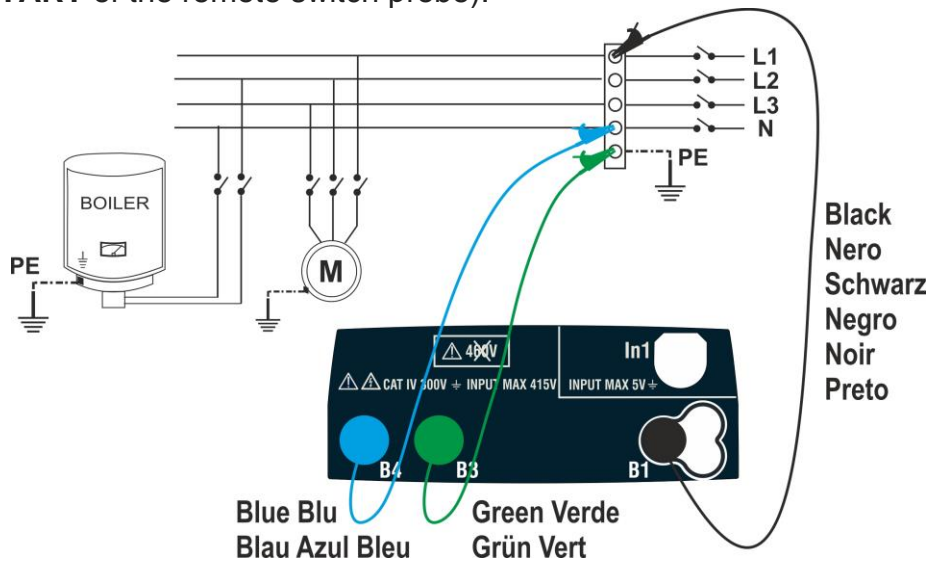

Fig. 13: Insulation test between L-N-PE by means of single cables (MAN and AUTO modes)

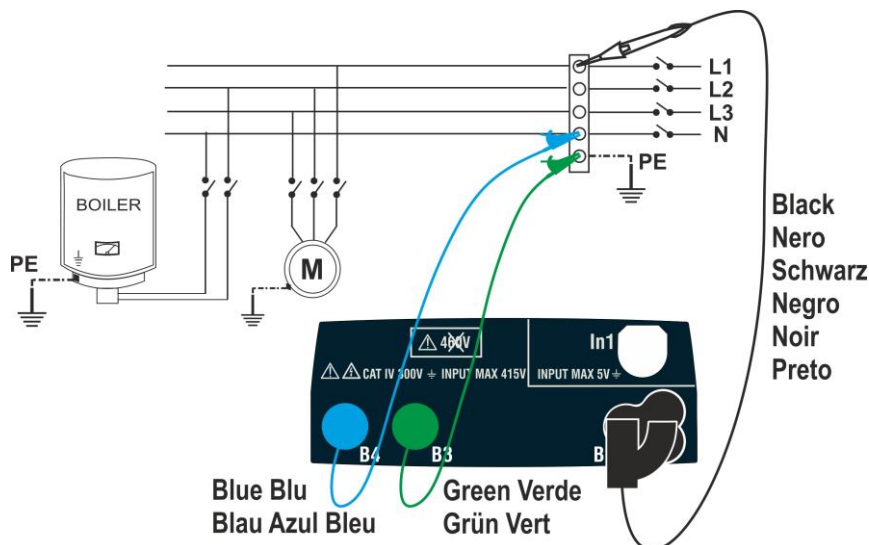

Fig. 14: Insulation between L-N-PE with single cables and remote switch probe (MAN and AUTO)

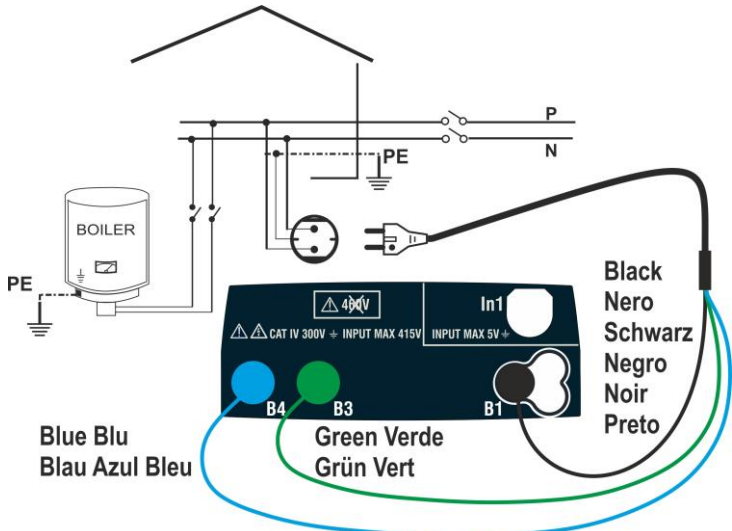

Fig. 15: Insulation between L-N-PE by means of mains plug (MAN and AUTO)

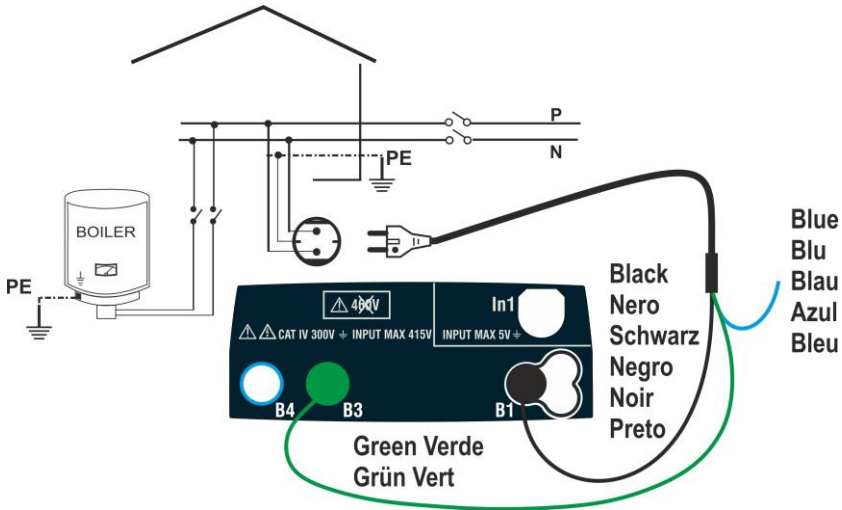

Fig. 16: Insulation between L-PE by means of mains plug (TMR mode)

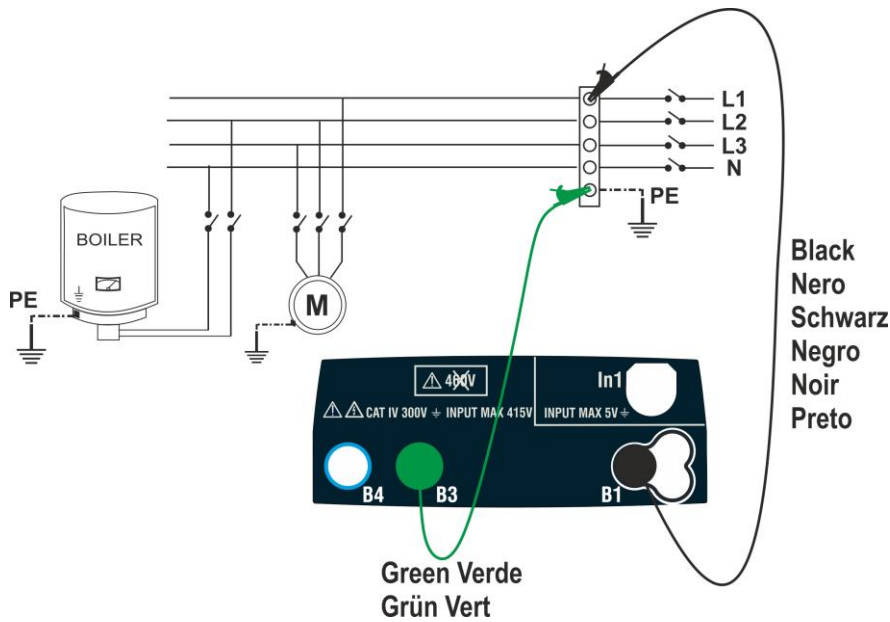

Fig. 17: Insulation between L-PE by means of single cables (TMR mode)

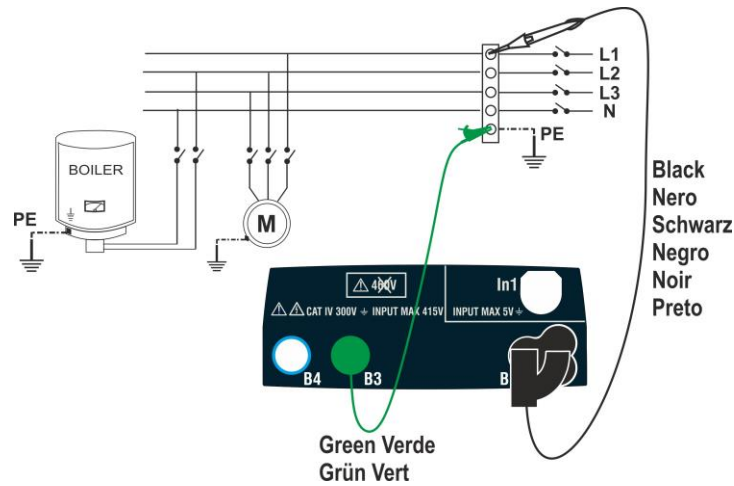

Fig. 18: Insulation between L-PE by means of single cables and remote switch probe (TMR mode))

1. Press the **MENU** key, move the cursor to **MΩ** in the main menu by means of the arrow keys (▲, ▼) and confirm with **ENTER**. Subsequently, the instrument displays a screen similar to the one reported here to the side.

M Ω	15/10 – 18:04		
R	=	- - -	M Ω
V t	=	- - -	V
T	=	- - -	s
MAN	500V	1.00MΩ	L-PE
<b>MODE</b>	Vtest	Lim.	<b>FUNC</b>

2. Use the ◀, ▶ keys to select the parameter to be modified, and the ▲, ▼ keys to modify the parameter value:
  - **MODE** → This key allows setting the test mode. The following options are available: **MAN, TMR, AUTO**.
  - **Vtest** → This key allows selecting the DC test voltage generated during measurement. The following values are available: **50V, 100V, 250V, 500V, 1000V**.
  - **Lim** → This key allows the selection of the minimum limit threshold in order to consider the measurement correct. The following values are available: **0.05MΩ, 0.10MΩ, 0.23MΩ, 0.25MΩ, 0.50MΩ, 1.00MΩ, 100MΩ**.
  - **FUNC** → This key allows setting the connection type L-N, L-PE or N-PE in MAN mode.
  - **Temp** → Only in TMR mode, this virtual key allows setting the duration time of test in the range: **3s ÷ 999s**.
3. We suggest setting the value of the voltage supplied while measuring and the minimum limit to consider the measure correct according to the prescriptions of the reference standard (see § 12.2).
4. Insert the green and black connectors of the single cables into the corresponding inputs B1, B3, B4 (MAN and AUTO modes) or B1, B3 (TMR mode) of the instrument. Apply the relevant alligator clips to the free ends of the cables. It is also possible to use the remote switch probe by inserting its multipolar connector into the input B1. Should the length of the cables provided be insufficient for the measurement to be performed, extend the green cable.

**CAUTION**



- Disconnect any cable not strictly involved in measurement.
- Before connecting the test leads, make sure that there is no voltage at the ends of the conductors to be tested.

5. Connect the test leads and remote switch probe to the ends of the conductors to be tested as shown in Fig. 13, Fig. 14, Fig. 15, Fig. 16, Fig. 17, or Fig. 18.
6. Press the **GO/STOP** key on the instrument or the **START** key on the remote switch probe. The instrument will start the measurement.

**CAUTION**



If message "**Measuring...**" appears on the display, the instrument is performing measurement. During this whole stage, do not disconnect the test leads of the instrument from the conductors under test, as the circuit being tested could remain charged with a dangerous voltage due to the stray capacitances of the system.

7. Regardless of the operating mode selected, the instrument, at the end of each test, applies a resistance to the output leads to discharge the stray capacitances in the circuit.

8. At the end of measurement (fixed duration of 3s), the instrument shows on the display the message "**OK**" in case of a positive result (value higher than the set minimum limit threshold) or "**NOT OK**" in case of a negative result (value lower than the minimum limit threshold set). The message "**>999MΩ**" indicates the instrument's out of scale, which normally appears to be the best possible result.

MΩ	15/10 – 18:04			■
R	>	999 MΩ		
Vt	=	512 V		
T	=	3	s	
<b>OK</b>				
MAN	500V	1.00MΩ	L-PE	
<b>MODE</b>	Vtest	Lim.	FUNC	

9. Press the **SAVE** key to store the test result in the instrument's memory (see § 7.1) or the **ESC/MENU** key to exit the screen without saving and go back to the main measuring screen.

### 6.5.1. TMR mode

- With the arrow keys ( $\blacktriangle$ ,  $\blacktriangledown$ ) select the "TMR" option in the "Mode" section. The instrument displays a screen like the one shown to the side. Set the duration of the measurement in the "Time" section and follow the steps from point 2 to point 5 of § 6.4.

MΩ	15/10 – 18:04		
R	=	---	MΩ
Vt = --- V		T = --- s	
PI = ---		DAR = ---	
TMR	500V	1.00MΩ	10s
MODE	Vtest	Lim.	Time

- Press the **GO/STOP** key on the instrument or the **START** key on the remote switch probe. The instrument starts the measurement for the entire duration set, showing the "Measuring..." message. The instrument shows the message "OK" on the display in case of a positive result (value higher than the set minimum threshold) or "NOT OK" in case of a negative result (value lower than the minimum limit set).

MΩ	15/10 – 18:04		
R	=	102	MΩ
Vt = 523V		T = 10 s	
PI = ---		DAR = ---	
OK			
TMR	500V	1.00MΩ	10s
MODE	Vtest	Lim.	Time

- With a measurement duration  $\geq 60s$ , the instrument shows the indication of the DAR parameter (Dielectric Absorbtion Ratio) as shown in the screen to the side.

MΩ	15/10 – 18:04		
R	=	102	MΩ
Vt = 523V		T = 60 s	
PI = ---		DAR = 1.03	
OK			
TMR	500V	1.00MΩ	60s
MODE	Vtest	Lim.	Time

- With a measurement duration  $\geq 600s$ , the instrument shows the indication of the DAR parameter (Dielectric Absorbtion Ratio) and of the PI parameter (Polarisation Index) as shown in the screen to the side.

MΩ	15/10 – 18:04		
R	=	102	MΩ
Vt = 523V		T = 600 s	
PI = 1.00		DAR = 1.03	
OK			
TMR	500V	1.00MΩ	600s
MODE	Vtest	Lim.	Time

### 6.5.2. AUTO mode

- With the arrow keys (**▲**, **▼**) select the "AUTO" option in the "**Mode**" section. The instrument displays a screen like the one shown to the side. Set the duration of the measurement in the "**Time**" section and follow the steps from point 2 to point 5 of § 6.4.

The instrument performs the insulation test between: L-N, L-PE and N-PE. Since some loads could still be connected between L-N, the instrument performs a preliminary test by using 50V as test voltage. If the RL-N is higher than 50kΩ, a new insulation test between L-N is performed by using the Vtest value. Finally, the instrument performs L-PE and N-PE insulation test.

MΩ	15/10 – 18:04		
RL-N	= --- MΩ	Vt = --- V	
RL-PE	= --- MΩ	Vt = --- V	
RN-PE	= --- MΩ	Vt = --- V	
AUTO	500V	1.00MΩ	
<b>MODE</b>	Vtest	Lim.	

- Press the **GO/STOP** key on the instrument or the **START** key on the remote switch probe. The instrument starts the automatic sequential measurement of the insulation resistance between L-N, L-PE and N-PE respectively by showing the "**Measuring...**" message. The instrument shows the message "**OK**" on the display in case of a positive result of each test (value higher than the set minimum limit threshold) or "**NOT OK**" in case of a negative result of at least one test (value lower than the set minimum limit threshold).

MΩ	15/10 – 18:04		
RL-N	> 999 MΩ	Vt = 523 V	
RL-PE	= 250 MΩ	Vt = 525 V	
RN-PE	> 999 MΩ	Vt = 524 V	
<b>OK</b>			
AUTO	500V	1.00MΩ	
<b>MODE</b>	Vtest	Lim.	

- Press the **SAVE** key to store the test result in the instrument's memory (see § 7.1) or the **ESC/MENU** key to exit the screen without saving and go back to the main measuring screen.

### 6.5.3. Anomalous situations

1. If the instrument fails to generate the nominal voltage, it emits a long acoustic signal to indicate the negative result of the test and displays a screen like the one at the side.

MΩ	15/10 – 18:04			
R	=	0.01 MΩ		
Vt	=	0	V	
T	=	3	s	
<b>NOT OK</b>				
MAN	500V	1.00MΩ	L-PE	
<b>MODE</b>	Vtest	Lim.	FUNC	

2. At the end of the test, if the measured resistance value is lower than the set limit, the instrument emits a long acoustic signal to indicate the negative result of the test and displays a screen like the one at the side.

MΩ	15/10 – 18:04			
R	=	0.29 MΩ		
Vt	=	534	V	
T	=	3	s	
<b>NOT OK</b>				
MAN	500V	1.00MΩ	L-PE	
<b>MODE</b>	Vtest	Lim.	FUNC	

3. In AUTO mode, if the insulation measurement L-N is  $<50k\Omega = 0.05M\Omega$ , all the tests are completed or if the **STOP** key has been pressed, if  $RL-PE$  and  $RN-PE > Lim$  and  $Vt > Vnom$ , the instrument shows a screen like the one at the side. Disconnect the loads and resume the test.

MΩ	15/10 – 18:04			
RL-N	=	0.01MΩ	Vt = 15 V	
RL-PE	>	999 MΩ	Vt = 525 V	
RN-PE	>	999 MΩ	Vt = 524 V	
<b>Not OK – Check loads</b>				
AUTO	500V	1.00MΩ		
<b>MODE</b>	Vtest	Lim.		

4. At the end of the test, if the value of the test voltage is lower than the nominal value, the instrument displays a screen like the one at the side.

MΩ	15/10 – 18:04			
R	=	0.12 MΩ		
Vt	=	485	V	
T	=	3	s	
<b>Vtest not correct</b>				
MAN	500V	1.00MΩ	L-PE	
<b>MODE</b>	Vtest	Lim.	FUNC	

5. If the instrument detects a voltage **higher than 30V** at its terminals, it does not perform the test, emits a prolonged acoustic signal and displays a screen like the one at the side.

MΩ	15/10 – 18:04			
R	=	- - -	MΩ	
Vt	=	- - -	V	
T	=	- - -	s	
<b>Vin &gt;30V</b>				
MAN	500V	1.00MΩ	L-PE	
<b>MODE</b>	Vtest	Lim.	FUNC	

## 6.6. RCD: TEST ON DIFFERENTIAL SWITCHES

This function is performed in compliance with standard IEC/EN61557-6, BS7671 17th/18th edition and allows measuring the tripping time and current of molded-case differential switches of type A/F ( $\sim/\sim$ ), AC ( $\sim$ ), B/B+ ( $\sim/\sim$ ), CCID ( $\sim, \sim$ ) (USA country) and DD being General (G) and Selective (S).

### CAUTION





The instrument checks voltage on PE by comparing the voltage at B4 input and the ground potential induced on the instrument's side through the user's hand. Therefore, in order to check voltage on PE, **it is mandatory to hold the instrument case on the left or on the right side.**

### CAUTION



- Some combinations of test parameters could be unavailable in compliance with the technical specifications of the instrument and the RCD tables (see § 10.1 –empty cells of RCD tables mean unavailable situations)
- **The RCD-DD option is not included in the AUTO function sequence**

The following operating modes are available:

- **AUTO** the instrument performs tripping time measurement automatically with a leakage current equal to half, once or five times the set value of nominal current and with a leakage current in phase with the positive ( $\uparrow$ ) and negative ( $\downarrow$ ) half-wave of the mains voltage. Recommended mode for RDC test
- **AUTO**  the instrument performs tripping time measurement automatically with a leakage current equal to half, once or five times the set value of nominal current and with a leakage current in phase with the positive ( $\uparrow$ ) and negative ( $\downarrow$ ) half-wave of the mains voltage and also real tripping current
- **x $\frac{1}{2}$**  the instrument performs tripping time measurement with a leakage current equal to half the set value of nominal current with the positive ( $\uparrow$ ) and negative ( $\downarrow$ ) half-wave of the mains voltage
- **x1** the instrument performs tripping time measurement with a leakage current equal to once the set value of nominal current with the positive ( $\uparrow$ ) and negative ( $\downarrow$ ) half-wave of the mains voltage
- **x5** the instrument performs tripping time measurement with a leakage current equal to five times the set value of nominal current with the positive ( $\uparrow$ ) and negative ( $\downarrow$ ) half-wave of the mains voltage
-  the instrument performs measurement with an increasing leakage current. This test could be performed to determine the real tripping current of the RCD with the positive ( $\uparrow$ ) and negative ( $\downarrow$ ) half-wave of the mains voltage

### CAUTION



Testing an RCD causes the RCD's tripping. **Therefore, check that there are NO users or loads connected downstream of the RCD being tested which could be damaged by a system downtime.**

If possible, disconnect all loads connected downstream of the RCD as they could produce leakage currents further to those produced by the instrument, thus invalidating the results of the test.

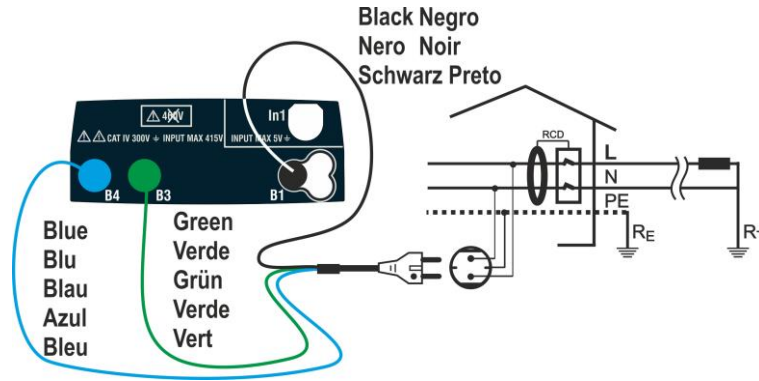

Fig. 19: Connection for single-phase L-N-PE system by means of mains plug

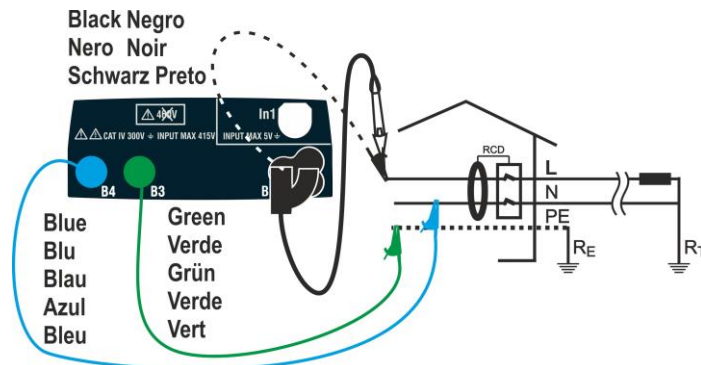

Fig. 20: Connection for single-phase L-N-PE system with single cables and remote switch probe

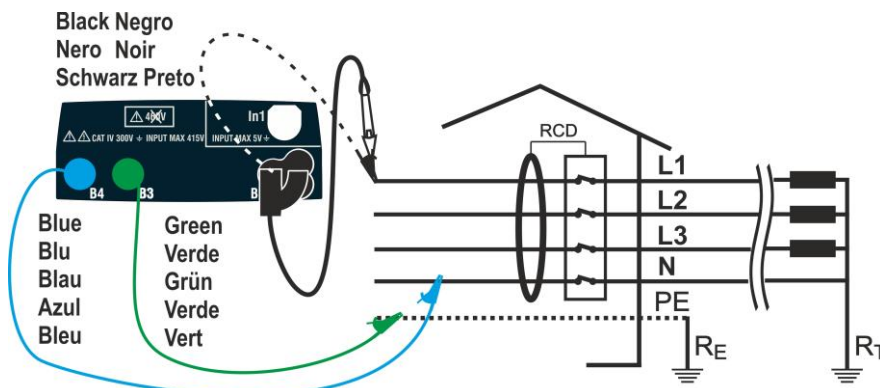

Fig. 21: Connection for three-phase L1-L2-L3-N system by means of single cables and remote switch probe

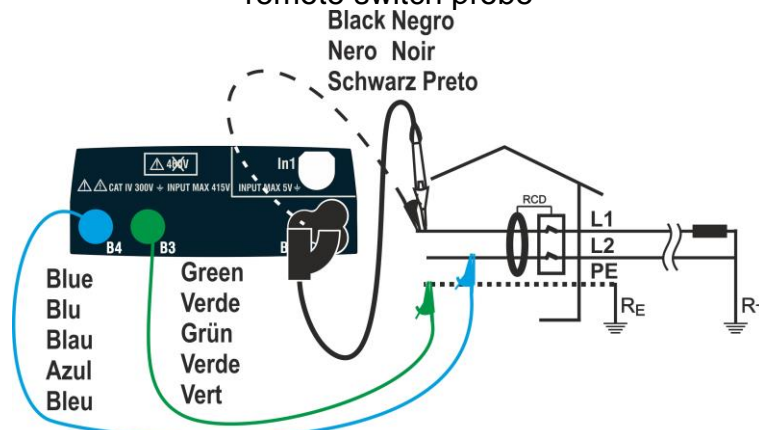

Fig. 22: Connection for L1-L2-PE split-phase system by means of single cables and remote switch probe

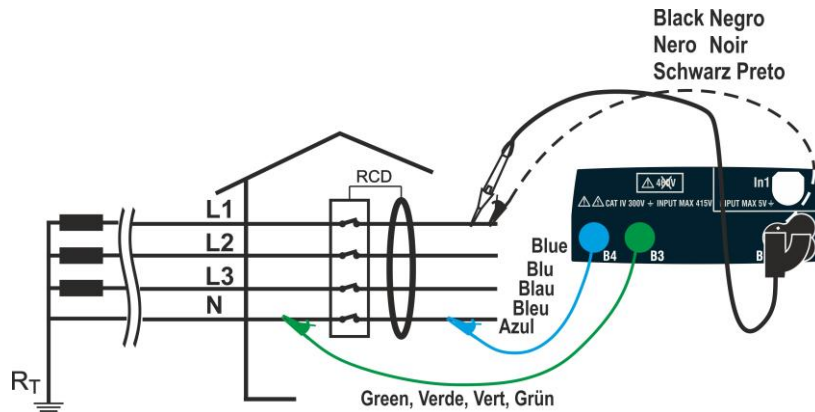

Fig. 23: Connection for three-phase L1-L2-L3-N (no PE) system by means of single cables and remote switch probe

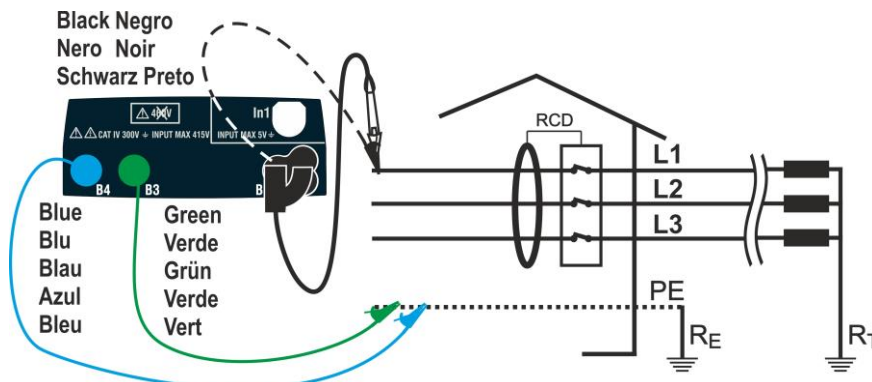

Fig. 24: Connection for L1-L2-L3-PE (no N) system with cables and remote switch probe

1. Press the **MENU** key, move the cursor to **RCD** in the main menu by means of the arrow keys (**▲**, **▼**) and confirm with **ENTER**. Subsequently, the instrument displays a screen similar to the one reported here to the side **in case of single-phase L-N-PE electrical system selected (see § 5.1.3). For split-phase L-L-PE systems the voltages indicated change in VL1-PE and VL1-L2**. Select a country (see § 5.1.2), the options “TN, TN or IT”, “25 or 50V”, “50Hz or 60Hz” and the reference voltage in the general settings of the instrument (see § 5.1.3).

RCD	15/10 – 18:04	■
TT		
T	= ...	ms
U <sub>t</sub>	= ...	V
FREQ.	= 0.00Hz	
VL-PE	= 0V	VL-N = 0V
X1	30mA	⤴
MODE	IΔn	Type Ut

2. Use the **◀**, **▶** keys to select the parameter to be modified, and the **▲**, **▼** keys to modify the parameter value:
  - **MODE** → The virtual key allows setting the measuring mode of the instrument, which may be: **AUTO**, **x<sup>1/2</sup>**, **x1**, **x5**, **■**
  - **IΔn** → The virtual key allows setting the nominal value of the RCD’s tripping current, which may be: **5mA**, **6mA**, **10mA**, **20mA**, **30mA**, **100mA**, **300mA**, **500mA**, **650mA**, **1000mA**
  - **Type** → The virtual key enables the selection of the RCD type, which may be: **A/F** (**⌚**/**⌚**S - General), **A/F**(**⌚**/**⌚**S - Selective), **AC** (**⌚** - General), **AC** (**⌚**S - Selective), **B/B+** (**⌚**/**⌚**), **DD** with polarity positive (⤴) or negative (⤵) and **CCID**⌚, **CCID**⌚ with polarity positive (⤴) or negative (⤵) (USA country)
  - **Ut** → The virtual key allows setting the possible visualization of the contact voltage value at the end of measurement. Options: **Ut** or **NoUt**

3. Insert the green, blue and black connectors of the three-pin plug cable into the corresponding inputs B3, B4 and B1 of the instrument. As an alternative, use the single cables and apply the relevant alligator clips to the free ends of the cables. It is also possible to use the remote switch probe by inserting its multipolar connector into the input B1. Connect the plug, the alligator clips or the remote switch probe to the electrical mains according to Fig. 19, Fig. 20, Fig. 21, Fig. 22, Fig. 23, Fig. 24.
4. Note the correct voltage values between L-N and L-PE as shown in the screen to the side.

RCD 15/10 - 18:04			
TT			
T	=	---	ms
Ut	=	---	V
FREQ. = 50.00Hz			
VL-PE=232V		VL-N=231V	
X1	30mA		
MODE	IΔn	Type	Ut

### 6.6.1. Mode AUTO

5. Press the **GO/STOP** key on the instrument, the **START** key on the remote switch probe or use the AutoStart feature (see § 5.1.5). The instrument will start the measurement.

RCD 15/10 - 18:04			
TT			
	0°	180°	
X1	38ms	---ms	
X5	---ms	---ms	
X½	---ms	---ms	
FREQ=50.00Hz Ut=---V			
VL-N=232V		VL-PE=231V	
Measuring...			
AUTO	30mA		
MODE	IΔn	Type	Ut



### CAUTION

If message **“Measuring...”** appears on the display, the instrument is performing measurement. During this whole stage, do not disconnect the test leads of the instrument from the mains.

6. The **AUTO** mode provides for the automatic execution of 6 measurements in a sequence:
  - IdN x 1 with phase 0° (the RCD must trip, reset the switch, message “Resume RCD” is shown)
  - IdN x 1 with phase 180° (the RCD must trip, reset the switch, message “Resume RCD” is shown)
  - IdN x 5 with phase 0° (the RCD must trip, reset the switch, message “Resume RCD” is shown)
  - IdN x 5 with phase 180° (the RCD must trip, reset the switch, message “Resume RCD” is shown)
  - IdN x½ with phase 0° (RCD must not trip)
  - IdN x½ with 180° (RCD must not trip, end of test)

RCD 15/10 - 18:04			
TT			
	0°	180°	
X1	38ms	---ms	
X5	---ms	---ms	
X½	---ms	---ms	
FREQ=50.00Hz Ut=---V			
VL-N=232V		VL-PE=231V	
Resume RCD			
AUTO	30mA		
MODE	IΔn	Type	Ut

7. In case of a **positive** result (all tripping times comply with what indicated in 12.4) of all the test sequentially performed, the “OK” message is shown and the screen to the side is displayed by the instrument.

RCD	15/10 – 18:04			
TN	0°	180°		
X1	38ms	35ms		
X5	22ms	27ms		
X½	>999ms	>999ms		
FREQ=50.00Hz Ut=0.0V				
VL-N=232V VL-PE=231V				
<b>OK</b>				
AUTO	30mA			
<b>MODE</b>	IΔn	Type	Ut	

8. Press the **SAVE** key to store the test result in the instrument’s memory (see § 7.1) or the **ESC/MENU** key to exit the screen without saving and go back to the main measuring screen.

**6.6.2. Mode AUTO**

5. Press the **GO/STOP** key on the instrument, the **START** key on the remote switch probe or use the AutoStart feature (see § 5.1.5). The instrument will start the measurement.

RCD	15/10 – 18:04			
TT	0°	180°		
	---	mA	---	mA
X1	---	ms	---	ms
X5	---	ms	---	ms
X½	---	ms	---	ms
FREQ.=50.0Hz Ut = - - - V				
VL-PE= 231V VL-N = 232V				
<b>Measuring...</b>				
AUTO		30mA		
<b>MODE</b>	IΔn	Type	Ut	

**CAUTION**



If message “**Measuring...**” appears on the display, the instrument is performing measurement. During this whole stage, do not disconnect the test leads of the instrument from the mains.

6. The **AUTO** mode provides for the automatic execution of 8 measurements in a sequence:

- (Ramp) with phase 0° (the RCD must trip, reset the switch, message “Resume RCD” is shown)
- (Ramp) with phase 180° (the RCD must trip, reset the switch, message “Resume RCD” is shown)
- IdN x 1 with phase 0° (the RCD must trip, reset the switch, message “Resume RCD” is shown)
- IdN x 1 with phase 180° (the RCD must trip, reset the switch, message “Resume RCD” is shown)
- IdN x 5 with phase 0° (the RCD must trip, reset the switch, message “Resume RCD” is shown)
- IdN x 5 with phase 180° (the RCD must trip, reset the switch, message “Resume RCD” is shown)
- IdN x½ with phase 0° (RCD must not trip)
- IdN x½ with 180° (RCD must not trip, end of test)

RCD	15/10 – 18:04			
TT	0°	180°		
	23	mA	---	mA
X1	---	ms	---	ms
X5	---	ms	---	ms
X½	---	ms	---	ms
FREQ.=50.0Hz Ut = - - - V				
VL-PE= 231V VL-N = 232V				
<b>Resume RCD.</b>				
AUTO		30mA		
<b>MODE</b>	IΔn	Type	Ut	

7. In case of a **positive** result (all tripping times comply with what indicated in 12.4) of all the tests sequentially performed, the “**OK**” message is shown and the screen to the side is displayed by the instrument.

RCD	15/10 – 18:04			
TT	0°	180°		
	23	mA	23	mA
X1	23	ms	23	ms
X5	15	ms	15	ms
X½	>999	ms	>999	ms
FREQ.	= 50.0Hz		Ut = 1 V	
VL-PE	= 231V		VL-N = 232V	
<b>OK.</b>				
AUTO		30mA		
MODE	IΔn	Type	Ut	

8. Press the **SAVE** key to store the test result in the instrument’s memory (see § 7.1) or the **ESC/MENU** key to exit the screen without saving and go back to the main measuring screen.

### 6.6.3. Mode x½, x1, x5

5. Press the **GO/STOP** key on the instrument, the **START** key on the remote switch probe or use the AutoStart feature (see § 5.1.5). The instrument will start the measurement.

RCD	15/10 – 18:04			
TT				
T	=	---	ms	
Ut	=	---	V	
FREQ. = 0.00Hz				
VL-PE=0V		VL-N=0V		
<b>Measuring...</b>				
X1	30mA			
MODE	IΔn	Type	Ut	

## CAUTION



If message “**Measuring...**” appears on the display, the instrument is performing measurement. During this whole stage, do not disconnect the test leads of the instrument from the mains.

6. When the RCD trips and breaks the circuit, if the tripping time is within the limits reported in 12.4, the instrument gives a double acoustic signal, shows the “**OK**” message and displays the screen to the side.

RCD	15/10 – 18:04			
TT				
T	=	38	ms	
Ut	=	1	V	
FREQ. = 50.00Hz				
VL-PE=231V		VL-N=234V		
<b>OK</b>				
X1	30mA			
MODE	IΔn	Type	Ut	

7. Press the **SAVE** key to store the test result in the instrument’s memory (see § 7.1) or the **ESC/MENU** key to exit the screen without saving and go back to the main measuring screen.

#### 6.6.4. Mode

The standard defines the tripping times for RCDs at nominal current. The mode is used to detect the tripping time at tripping current (which could also be lower than the nominal current).

- Press the **GO/STOP** key on the instrument, the **START** key on the remote switch probe or use the AutoStart feature (see § 5.1.5). The instrument will start the measurement.

RCD 15/10 – 18:04			
TT			
I = --- mA			
T = --- ms Ut = --- V			
FREQ. = 50.00Hz			
VL-PE=231V VL-N=234V			
<b>Measuring...</b>			
30mA			
MODE	IΔn	Type	Ut



### CAUTION

If message “**Measuring...**” appears on the display, the instrument is performing measurement. During this whole stage, do not disconnect the test leads of the instrument from the mains.

- According to standard EN61008, the test for selective RCDs requires an interval of 60 seconds between the tests. **The mode is therefore unavailable for selective RCDs, both of A and of AC type.**

- When the RCD trips and breaks the circuit, if the tripping current and tripping time are within the limits reported in 12.4, the instrument gives a double acoustic signal, shows the “**OK**” message and displays the screen to the side.



RCD 15/10 – 18:04			
TT			
I = 24 mA			
T = 38 ms Ut = 1 V			
FREQ. = 50.00Hz			
VL-PE=231V VL-N=234V			
<b>OK</b>			
30mA			
MODE	IΔn	Type	Ut

- Press the **SAVE** key to store the test result in the instrument’s memory (see § 7.1) or the **ESC/MENU** key to exit the screen without saving and go back to the main measuring screen.

### 6.6.5. Mode DD

The standard IEC62955 defines the tripping times and current for **RCD-DD (Detecting Devices)** types at nominal current of 6mA only. **The x1 and  options are only available in this mode**

5. Press the **GO/STOP** key on the instrument, the **START** key on the remote switch probe or use the AutoStart feature (see § 5.1.5). The instrument will start the measurement.



RCD 15/10 – 18:04 			
TT			
I = --- mA			
T = --- ms Ut = --- V			
FREQ. = 50.00Hz			
VL-PE=231V VL-N=234V			
<b>Measuring...</b>			
 6mA DD↑			
MODE	IΔn	Type	Ut





### CAUTION

If message “**Measuring...**” appears on the display, the instrument is performing measurement. During this whole stage, do not disconnect the test leads of the instrument from the mains.

6. When the RCD trips and breaks the circuit, if the tripping current and tripping time are within the limits reported in § 10.1, the instrument gives a double acoustic signal, shows the “**OK**” message and displays the screen to the side.

RCD 15/10 – 18:04 			
TT			
I = 4.5 mA			
T = 219 ms Ut = 0 V			
FREQ. = 50.00Hz			
VL-PE=231V VL-N=234V			
<b>OK</b>			
 6mA DD↑			
MODE	IΔn	Type	Ut

7. When the RCD trips and breaks the circuit, if the tripping current and tripping time are external the limits reported in 10.1, the instrument gives a double acoustic signal, shows the “**NOT OK**” message and displays the screen to the side.

RCD 15/10 – 18:04 			
TT			
I = 1.2 mA			
T = 462 ms Ut = 0 V			
FREQ. = 50.00Hz			
VL-PE=231V VL-N=234V			
<b>NOT OK</b>			
 6mA DD↑			
MODE	IΔn	Type	Ut

8. Press the **SAVE** key to store the test result in the instrument’s memory (see § 7.1) or the **ESC/MENU** key to exit the screen without saving and go back to the main measuring screen

### 6.6.6. Mode CCID (TN systems – USA country)

The instrument allows to measure the tripping times and current for **RCD** types **CCID** (sinusoidal waveform) or **CCID** (continue waveform) at nominal currents of **5mA** or **20mA**. The x1 and options are only available in this mode

5. Press the **GO/STOP** key on the instrument, the **START** key on the remote switch probe or use the AutoStart feature (see § 5.1.5). The instrument will start the measurement.

RCD	15/10 – 18:04		
TN	I = --- mA		
T = --- ms	Ut = --- V		
FREQ. = 60.00Hz			
VL1-PE=120V		VL1-L2=240V	
<b>Measuring...</b>			
20mA		CCID $\sim$ ↑	
<b>MODE</b>	IΔn	Type	Ut



### CAUTION

If message “**Measuring...**” appears on the display, the instrument is performing measurement. During this whole stage, do not disconnect the test leads of the instrument from the mains.

6. When the RCD trips and breaks the circuit, if the tripping current and tripping time are within the limits reported in § 10.1, the instrument gives a double acoustic signal, shows the “**OK**” message and displays the screen to the side.

RCD	15/10 – 18:04		
TN	I = 15 mA		
T = 219 ms	Ut = 0 V		
FREQ. = 60.00Hz			
VL1-PE=120V		VL1-L2=240V	
<b>OK</b>			
20mA		CCID $\sim$ ↑	
<b>MODE</b>	IΔn	Type	Ut

7. When the RCD trips and breaks the circuit, if the tripping current and tripping time are external the limits reported in 10.1, the instrument gives a double acoustic signal, shows the “**NOT OK**” message and displays the screen to the side.

RCD	15/10 – 18:04		
TN	I = 1.2 mA		
T = 462 ms	Ut = 0 V		
FREQ. = 60.00Hz			
VL1-PE=120V		VL1-L2=240V	
<b>NOT OK</b>			
20mA		CCID $\sim$ ↑	
<b>MODE</b>	IΔn	Type	Ut

8. Press the **SAVE** key to store the test result in the instrument’s memory (see § 7.1) or the **ESC/MENU** key to exit the screen without saving and go back to the main measuring screen

### 6.6.7. Anomalous situations

1. If the instrument detects a frequency higher than the maximum limit (63Hz), it does not carry out the test and displays a screen like the one to the side.

RCD	15/10 – 18:04		
TT			
T	=	---	ms
Ut	=	---	V
FREQ. = >63Hz			
VL-PE=231V		VL-N=234V	
<b>Freq. out of range</b>			
X1	30mA		
<b>MODE</b>	IΔn	Type	Ut

2. If the instrument detects a L-N or L-PE voltage lower than the minimum limit (100V), it does not carry out the test and displays a screen like the one to the side. Check that the system being tested is supplied

RCD	15/10 – 18:04		
TT			
T	=	---	ms
Ut	=	---	V
FREQ. = 0.00 Hz			
VLPE=<100V		VL-N=<100V	
<b>Voltage &lt;100V</b>			
X1	30mA		
<b>MODE</b>	IΔn	Type	Ut

3. If the instrument detects a L-N or L-PE voltage higher than the maximum limit (265V), it does not carry out the test and displays a screen like the one to the side. Check the connection of measuring cables.

RCD	15/10 – 18:04		
TT			
T	=	---	ms
Ut	=	---	V
FREQ. = 50.00 Hz			
VLPE=>265V		VL-N=>265V	
<b>Voltage &gt;265V</b>			
X1	30mA		
<b>MODE</b>	IΔn	Type	Ut

4. If the instrument detects a dangerous voltage on PE conductor, it provides the warning screen shown to the side and blocks the execution of the tests. Check the PE conductor and earth connection efficiency.

RCD	15/10 – 18:04		
TT			
T	=	---	ms
Ut	=	---	V
FREQ. = 0.00Hz			
VL-PE=- - -V		VL-N=- - -V	
<b>Voltage on PE</b>			
X1	30mA		
<b>MODE</b>	IΔn	Type	Ut

5. If the instrument detects that the phase L and neutral N leads are inverted, it does not carry out the test and a screen similar to the one reported to the side is displayed. Rotate the mains plug or check the connection of measuring cables.

RCD	15/10 – 18:04	
TT		
T	= --- ms	
Ut	= --- V	
FREQ. = 50.00Hz		
VL-PE= 1V VL-N=231V		
<b>Exchange L-N</b>		
X1	30mA	
MODE	IΔn	Type Ut

6. If the instrument detects that the phase and PE leads are inverted, it does not carry out the test and a screen similar to the one reported to the side is displayed. Check the connection of measuring cables.

RCD	15/10 – 18:04	
TT		
T	= --- ms	
Ut	= --- V	
FREQ. = 50.00Hz		
VL-PE=231V VL-N=1V		
<b>Exchange L-PE</b>		
X1	30mA	
MODE	IΔn	Type Ut

7. If the instrument detects the absence of the signal to terminal B3 (PE conductor), it provides the warning screen shown to the side and blocks the execution of the tests.

RCD	15/10 – 18:04	
TT		
T	= --- ms	
Ut	= --- V	
FREQ. = 50.00 Hz		
VL-PE= 114V VL-N=231V		
<b>Missing PE</b>		
X1	30mA	
MODE	IΔn	Type Ut

8. If the instrument detects the absence of the signal to terminal B4 (neutral conductor), it provides the warning screen shown to the side and blocks the execution of the tests.

RCD	15/10 – 18:04	
TT		
T	= --- ms	
Ut	= --- V	
FREQ. = 50.00 Hz		
VL-PE= 231V VL-N=115V		
<b>Missing N</b>		
X1	30mA	
MODE	IΔn	Type Ut

9. If the instrument detects the absence of the signal to terminal B1 (phase conductor), it provides the warning screen shown to the side and blocks the execution of the tests.

RCD	15/10 – 18:04	
TT		
T	= --- ms	
Ut	= --- V	
FREQ. = 50.00 Hz		
VL-PE= 0V VL-N=0V		
<b>Missing P</b>		
X1	30mA	
MODE	IΔn	Type Ut

10. If the instrument detects a dangerous contact voltage  $U_t$  (above the set limit of 25V or 50V) in the initial pre-test, it provides the warning screen shown to the side and blocks the execution of the tests. Check the PE conductor and earth connection efficiency.

RCD	15/10 – 18:04	
TT		
T	= --- ms	
Ut	= --- V	
FREQ. = 50.00 Hz		
VL-PE= 231V VL-N=232V		
<b>Cont. Voltage &gt; Lim</b>		
X1	30mA	
MODE	IΔn	Type Ut

11. If the RCD does not trip within the maximum duration of the test, the instrument gives a long acoustic signal which signals the negative result of the test and then displays a screen similar to the one reported here to the side. Check that the set type of RCD matches the type of RCD being tested.

RCD	15/10 – 18:04	
TT		
T	= > 999 ms	
Ut	= 1 V	
FREQ. = 50.00 Hz		
VL-PE= 231V VL-N=232V		
<b>NOT OK</b>		
X1	30mA	
MODE	IΔn	Type Ut

12. If the instrument detects, at the input terminals, too high an external impedance so that it cannot let the nominal current flow, it provides the warning screen shown to the side and blocks the test. Disconnect the possible loads downstream of the RCD before performing the test

RCD	15/10 – 18:04	
TT		
T	= --- ms	
Ut	= --- V	
FREQ. = 50.00 Hz		
VL-PE= 231V VL-N=232V		
<b>Ext. Impedance too high</b>		
X1	30mA	
MODE	IΔn	Type Ut

## 6.7. LOOP: LINE/LOOP IMPEDANCE AND OVERALL EARTH RESISTANCE

This function is performed in compliance with standard IEC/EN61557-3, BS7671 17th/18th edition and allows measuring the line impedance, the fault loop impedance and the prospective short-circuit current.



### CAUTION

Depending on the selected electrical system (TT, TN or IT), some connections and function modes are disabled by the instruments (see Table 1)

The following operating modes are available:

- **L-N** Standard (STD) measurement of the line impedance between the phase conductor and the neutral conductor and calculation of the prospective phase-to-neutral short-circuit current for L-N-PE and L-L-PE systems
- **L-L** Standard (STD) measurement of the line impedance between the two phase conductors and calculation of the prospective phase-to-phase short-circuit current for L-N-PE and L-L-PE systems
- **L-PE** Standard (STD) measurement of the fault loop impedance between the phase conductor and the earth conductor and calculation of the prospective phase-to-earth short-circuit current for L-N-PE and L-L-PE systems
- **Ra  $\ddagger$**  Fault loop impedance without causing the protections' tripping in TN systems (see § 12.7) and overall earth resistance (TT systems) with neutral (3-wire) and without neutral (2-wire) (see § 12.8) for L-N-PE and L-L-PE systems
- **L1-L2** Standard (STD) measurement of the line impedance between the two phase conductor L1 and L2 of a split-phase systems and the earth conductor and calculation of the prospective phase-to-earth short-circuit current for L-L-PE systems
- **L1-PE** Standard (STD) measurement of the fault loop impedance between the phase conductor and the earth conductor of a split-phase systems and calculation of the prospective phase-to-earth short-circuit current for L-L-PE systems

### CAUTION



The instrument checks voltage on PE by comparing the voltage at B4 input and the ground potential induced on the instrument's side through the user's hand. Therefore, in order to check voltage on PE, **it is mandatory to hold the instrument case on the left or on the right side.**

### CAUTION



The measurement of line impedance or fault loop impedance involves the circulation of a maximum current according to the technical specifications of the instrument (see § 10.1). This could cause the tripping of possible magnetothermal or differential protections at lower tripping currents.

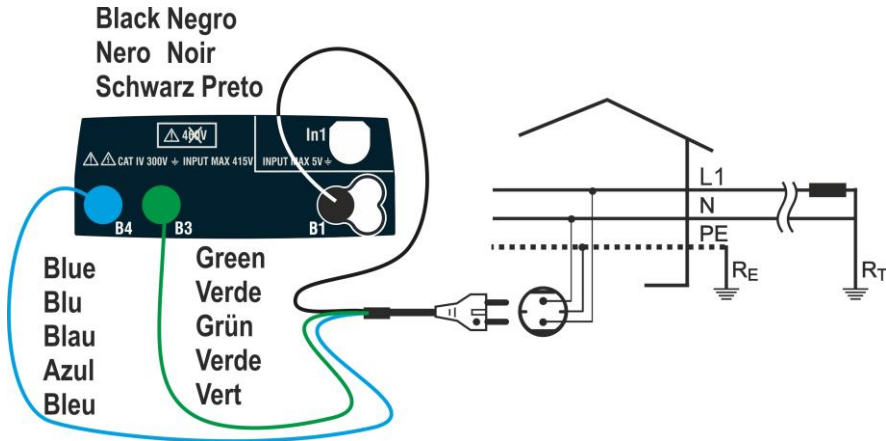

Fig. 25: L-N/L1-PE test for single-phase/split-phase systems with mains plug

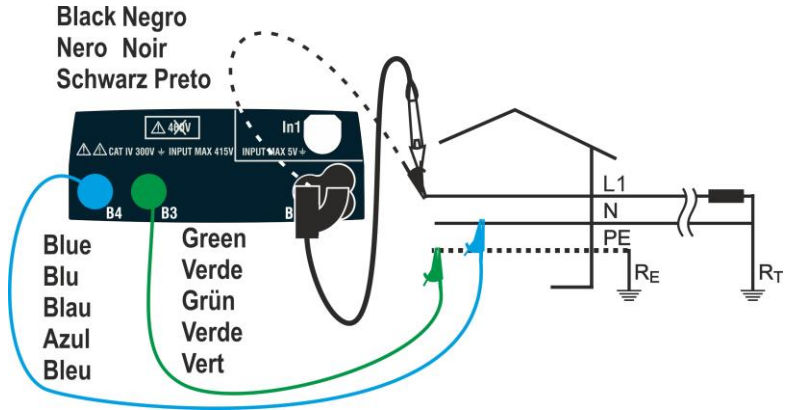

Fig. 26: L-N/L1-PE test for single-phase/split-phase systems with cables and remote probe

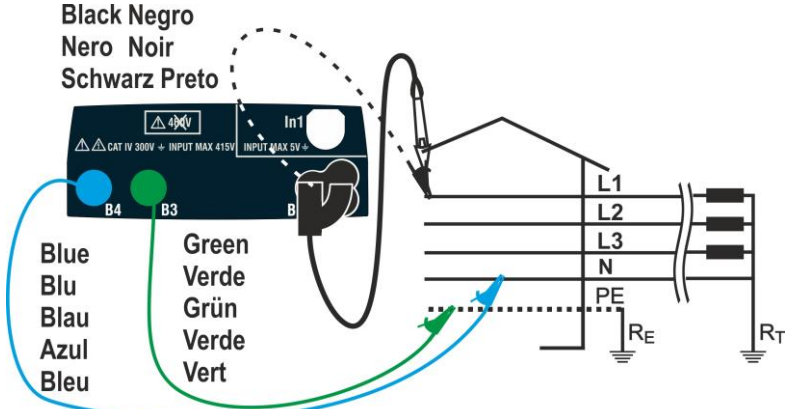

Fig. 27: L-N/L1-PE test for three-phase with single cables and remote probe

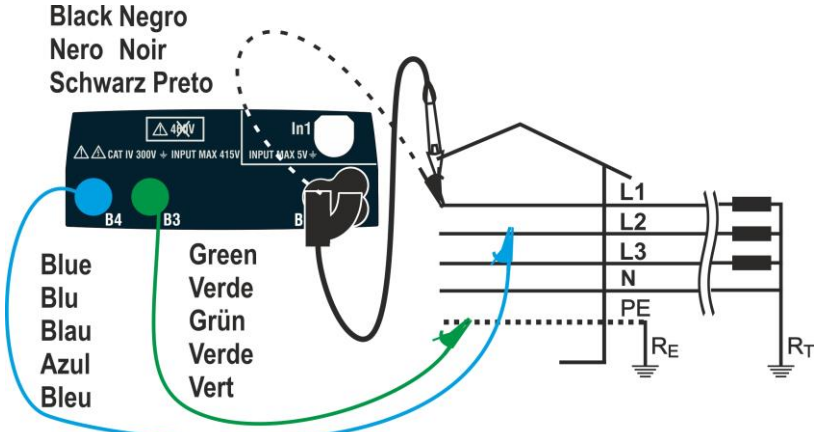

Fig. 28: L1-L2 measurement for three-phase systems

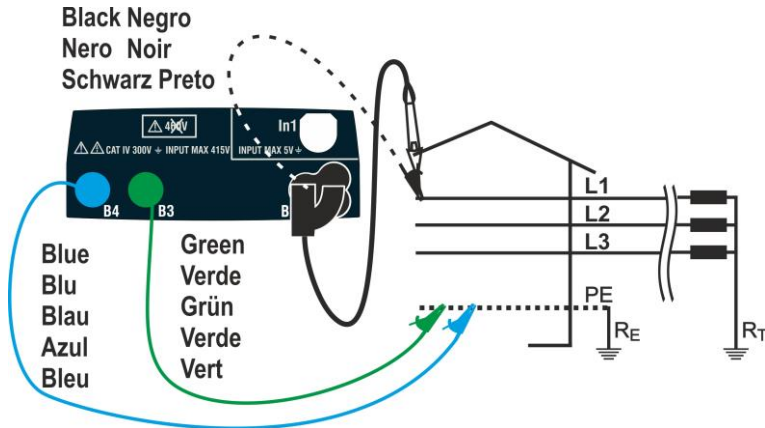

Fig. 29: L-PE/L1-PE test for three-phase systems (no N) with single cables and remote probe

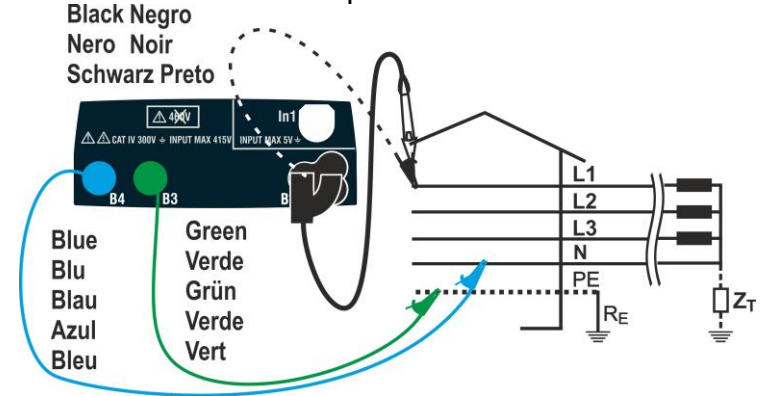

Fig. 30: L1-PE measurement for IT systems by means of single cables and remote probe

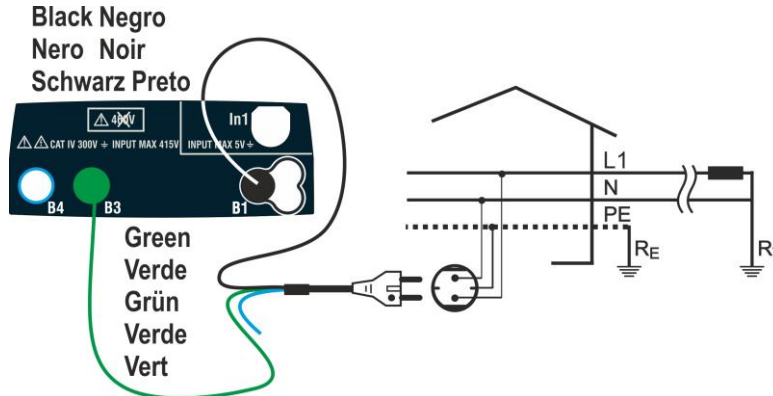

Fig. 31: L1-PE 2-wire test for single-phase/splt-phase systems with mains plug

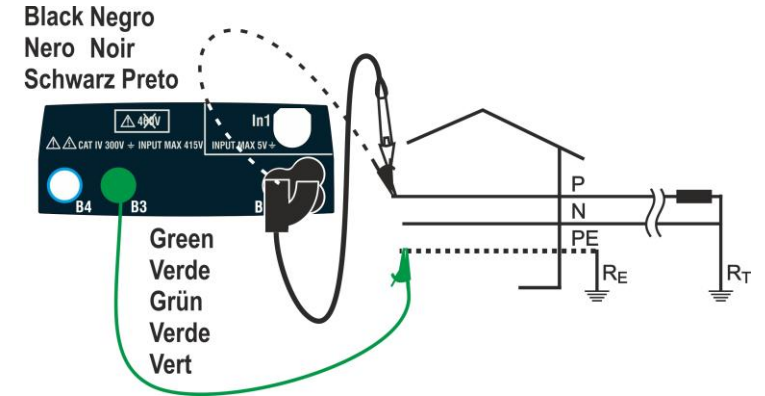

Fig. 32: L1-PE 2-wire test for single-phase/splt-phase systems with cables and remote probe

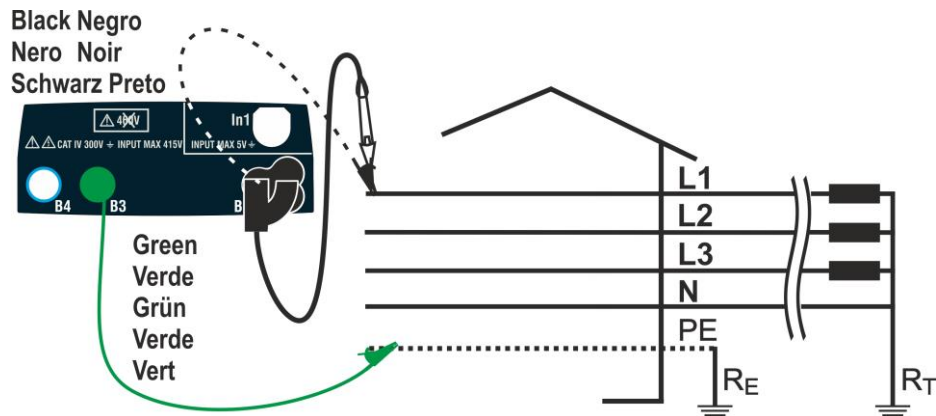

Fig. 33: L1-PE 2-wire test for three-phase with single cables and remote probe

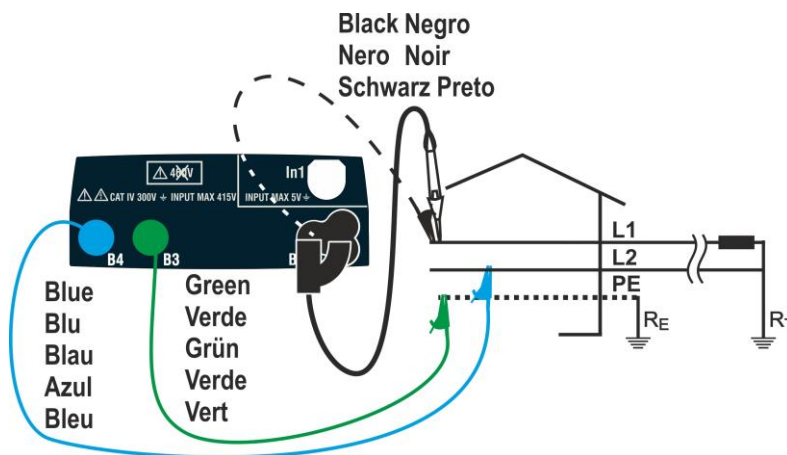

Fig. 34: L1-L2 3-wire test for split-phase with single cables and remote probe

### 6.7.1. Test types

The protection of electrical lines is the essential part of a project to guarantee correct functionality and avoid injury to persons or damage of property. To this purpose, the safety guidelines impose on electrical designers to also design the electrical installation in order to obtain:

1. The protection from short-circuits, i.e. the breaking capacity of the protection device must not be lower than the prospective short-circuit current in the point in which the device is installed.
2. The protection from indirect contacts.

In order to verify the a.m. conditions, the instrument performs the following functions:

**Ra  $\neq$  (Ut) Check of protection from indirect contact** – According to the type of distribution system (TT, TN, IT) set by the user, the instrument performs the measurement and verifies the condition imposed by the guidelines. Should it be reached, the instrument gives a positive outcome (see § 12.6, 12.8, 12.9).

**Br.Cap Check of protection's breaking capacity** – The instrument detects the value of the line impedance upstream of the measured point, calculates the maximum value of short-circuit current and gives a positive outcome if the value is lower than the limit set by the user (see § 12.5).

**TripT Check of the coordination of protections** – The instrument detects the value of the line impedance upstream of the measured point, calculates the minimum value of short-circuit current and the corresponding value of the trip-out time (t) of the protection device, and gives a positive outcome if the value is lower than the limit set by the user (see § 12.10).

**STD** Generic test

The following table summarizes the possible measures executable depending on the type of system (TT, TN and IT), of selected modes and the relationships that define limit values.

		TT	TN	IT
Mode		Condition x OK outcome	Condition x OK outcome	Condition x OK outcome
L-L L1-L2	STD	No outcome	No outcome	No outcome
	Br.Cap	Isc L-L max < BC Isc L1-L2 max < BC	Isc L-L max < BC Isc L1-L1 max < BC	Isc L-L max < BC Isc L1-L2 max < BC
	TripT	(IscL-Lmin 2P) → Tmax → Tmax < Tlim (IscL1-L2min 2P) → Tmax → Tmax < Tlim	(IscL-L min 2P) → Tmax → Tmax < Tlim (IscL1-L2 min 2P) → Tmax → Tmax < Tlim	(IscL-Lmin 2F) → Tmax → Tmax < Tlim (IscL1-L2min 2F) → Tmax → Tmax < Tlim
	Ut			
L-N	STD	No outcome	No outcome	No outcome
	Br.Cap	Isc L-N max < BC	Isc L-N max < BC	Isc L-N max < BC
	TripT	(Isc L-N min ) → Tmax → Tmax < Tlim	(Isc L-N min ) → Tmax → Tmax < Tlim	(Isc L-N min ) → Tmax → Tmax < Tlim
	Ut			
L-PE L1-PE	STD		No outcome	
	Br.Cap		Isc L-PE max < BC Isc L1-PE max < BC	
	TripT		(Ipfc L-PE min ) → Tmax → Tmax < Tlim (Ipfc L1-PE min ) → Tmax → Tmax < Tlim	
	Ut		ZL-PE < ZLimit (UK) ZL1-PE < ZLimit (USA)	Utmeas < Utlim
Ra 	Ut 2W	Utlim/Ra meas = Isc L-PE MIN > Idn (RCD)	ZLPEmis < ZLIM (UK, AUS/NZ) ZL1PEmis < ZLIM (USA) Ra meas x Idn < Ut lim (other Country)	
	Ut 3W		ZLPEmis < ZLIM (UK, AUS/NZ) ZL1PEmeas < ZLIM (USA) Ra meas x Idn < Ut lim (other Country)	

Table 1: Conditions of positive outcome depending on the test parameters

Where:

Empty cells	Mode unavailable for this particular combination of electric system
Isc L-L_Min2P	Prospective short-circuit current minimum split-phase L-L (system L-N-PE)
Isc L1-L2_Min2P	Prospective short-circuit current minimum split-phase L1-L2 (system L-L-PE)
Isc L-N_Max	Prospective short-circuit current maximum L-N (system L-N-PE)
Isc L-N_Min	Prospective short-circuit current minimum L-N (system L-N-PE)
Isc L-PE_Max	Prospective short-circuit current maximum L-PE (system L-N-PE)
Isc L1-PE_Max	Prospective short-circuit current maximum split-phase L1-PE (system L-L-PE)
Isc L-PE_Min	Prospective short-circuit current minimum L-PE (system L-N-PE)
Isc L1-PE_Min	Prospective short-circuit current minimum split-phase L1-PE (system L-L-PE)
BC	Breaking Capacity of the protection device - kA
Z Limit	Max allowed limit impedance according to type of protection
Tmax	Maximum trip-out time of the protection device
Tlim	Limit time of fault extinction by the protection set by the user
Ut meas	Contact voltage measured
Ut lim	Contact voltage limit (25V or 50V)
Ra meas	Overall earth resistance measured
Idn	Tripout current of RCD devices
Ipsc	Prospective short-circuit current
Ipfc	Prospective fault current

**6.7.2. Test cable calibration (ZEROLOOP)**

In order to obtain better results, it is strongly recommended to perform the preliminary calibration of the test cables or of the cable with mains plug by using the **ZEROLOOP** accessory before performing the test. In this way, the instrument automatically subtracts the resistance of the test cables, providing the actual result on the display. By way of example, the procedure for the LOOP STD Generic mode is described below and can be extended to all other cases.

1. Press the **MENU** key, move the cursor to **LOOP** in the main menu by means of the arrow keys (**▲**,**▼**) and confirm with **ENTER**. Select the function **“CAL”**. Subsequently, the instrument displays a screen similar to the one reported here to the side.

LOOP		15/10 – 18:04	■
TN			
RL	=	---	Ω
RN	=	---	Ω
RPE	=	---	Ω
FREQ. = 0.00Hz			
VL-PE=0V		VL-N=0V	
CAL			
FUNC			

2. Insert the **ZEROLOOP** metallic accessory into the three banana connectors of the measurement cables (L-N-PE) or into the metal connectors of the mains plug (differently for the various types depending on the country of use), as shown in the following

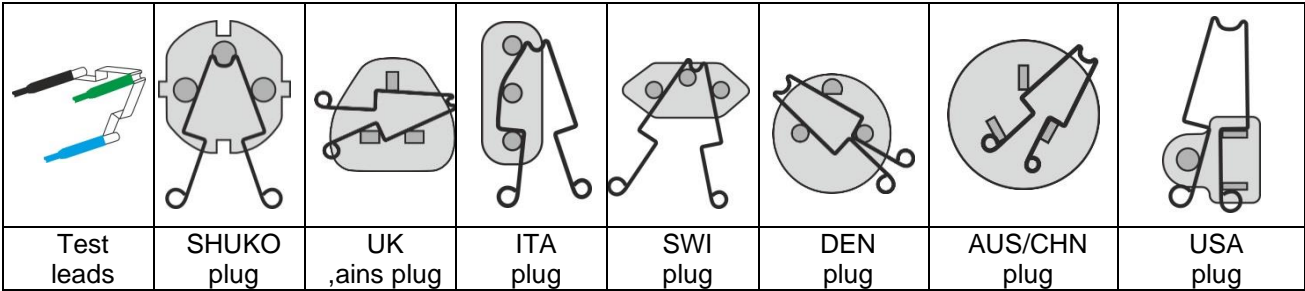

Table 2: Connection of ZEROLOOP accessory

3. Press the **GO/STOP** key to start calibration. In the **RL**, **RN** and **RPE** field, the resistance of test leads is shown for a few seconds. This value will automatically be subtracted by the instrument at the end of Loop measurement.

The instrument displays the **“▶◊◀”** symbol to indicate the positive outcome of test leads’ calibration (**Rcal <1Ω**) and the screen to the side appears on the display.

Go back to the measurement main screen. Note the **“▶◊◀”** symbol which means the successful test leads’ calibration and proceed with the measurements described in the following paragraphs.

LOOP		15/10 – 18:04	■
TN			
RL	=	0.051	Ω
RN	=	0.013	Ω
RPE	=	0.068	Ω
▶◊◀			
FREQ. = 0.00Hz			
VL-PE=0V		VL-N=0V	
Zeroing OK			
CAL			
FUNC			

4. The value of the test leads/mains plug resistance is maintained by the instrument up to the reset operation performed by the user (for example, for the insertion of cables with different lengths).

To reset the saved calibration value, remove the ZEROLOOP accessory and press the **GO/STOP** key. The “▶◀” symbol disappears and the screen to the side appears on the display.

LOOP	15/10 – 18:04	
TN		
RL	= ---	Ω
RN	= ---	Ω
RPE	= ---	Ω
FREQ. = 0.00Hz		
VL-PE=0V		VL-N=0V
Zero reset		
CAL		
FUNC		

### 6.7.3. STD Mode – Generic test

This mode performs the impedance measurement and the calculation of prospective short-circuit current without any evaluation. Therefore, at the end of the test, no outcome is given by the instrument.

- Press the **MENU** key, move the cursor to **LOOP** in the main menu by means of the arrow keys (**▲**,**▼**) and confirm with **ENTER**. Subsequently, the instrument displays a screen similar to the one reported here to the side **in case of single-phase L-N-PE electrical system selected (see § 5.1.3). For split-phase L-L-PE systems the voltages indicated change in VL1-PE and VL1-L2** Select “Europe” as a country (see § 5.1.2), the options “TN, TN or IT”, “25 or 50V”, “50Hz or 60Hz” the system “L-N-PE” or “L-L-PE” and the reference voltage in the general settings of the instrument (see § 5.1.3).

LOOP	15/10 – 18:04	■
TN		
Ipfc	= ---	A
ZL-PE	= ---	Ω
FREQ.	= 0.00Hz	
VL-PE=0V	VL-N=0V	
L-PE	STD	
<b>FUNC</b>	MODE	

- Use the **◀**, **▶** keys to select the parameter to be modified, and the **▲**, **▼** keys to modify the parameter value.
  - **FUNC** → the virtual key allows setting the measuring mode of the instrument, which may be: **L-N**, **L-L** or **L-PE** (single-phase/three-phase systems) or **L1-PE**, **L1-L2** (split-phase systems)
  - **MODE** → the virtual key allows setting the instrument’s operating mode. Select the **STD** option.
- If possible, disconnect all loads connected downstream of the point to be measured, as the impedance of these users could distort the test results. Perform the preliminary calibration of the test leads as described in § 6.7.2.
- Insert the green, blue and black connectors of the three-pin plug cable into the corresponding inputs B3, B4 and B1 of the instrument. As an alternative, use the single cables and apply the relevant alligator clips to the free ends of the cables. It is also possible to use the remote switch probe by inserting its multipolar connector into the input B1. Connect the mains plug, the alligator clips or the remote switch probe to the electrical mains according to Fig. 25, Fig. 26, Fig. 27, Fig. 28, Fig. 29, Fig. 30, Fig. 31, Fig. 32, Fig. 33 or Fig. 34

- Note the presence of the correct voltage values between L-N and L-PE corresponding to the selections carried out in the initial phase (see § 5.1.3) as shown in the screen to the side.

LOOP	15/10 – 18:04	■
TN		▶◀
Ipfc	= ---	A
ZL-PE	= ---	Ω
FREQ.	= 50.00Hz	
VL-PE=231V	VL-N=232V	
L-PE	STD	
<b>FUNC</b>	MODE	

6. Press the **GO/STOP** key on the instrument, the **START** key on the remote switch probe or use the AutoStart feature (see § 5.1.5). The instrument starts the measurement and the “**Measuring...**” message is shown on the display.

LOOP		15/10 – 18:04		
TN				
Ipfc	=	---	A	
ZL-PE	=	---	Ω	
FREQ. = 50.00Hz				
VL-PE=231V		VL-N=232V		
<b>Measuring...</b>				
L-PE	STD			
<b>FUNC</b>	MODE			

7. During this whole stage, do not disconnect the measuring leads of the instrument from the system under test. The following screen appears on the instrument's display.

The value of the prospective short-circuit current (Ipfc) is shown in the upper part of the display, while the Line/Fault loop Z<sub>L-PE</sub> impedance is shown in the bottom part of the display.

The Standard (Std) prospective short-circuit current (Isc) is calculated using the following formulas:

$$I_{SCL-PE} = \frac{U_{NOM}}{Z_{L-PE}} \quad I_{SCL-N} = \frac{U_{NOM}}{Z_{L-N}} \quad I_{SCL-L} = \frac{\sqrt{3} U_{NOM}}{Z_{L-L}}$$

Z<sub>MEAS</sub> = measured L-L,L-N,L-PE loop impedance

U<sub>NOM</sub> = nominal voltage (depending on the system)

RCD		15/10 – 18:04		
TN				
Ipfc	=	163	A	
ZL-PE	=	1.41	Ω	
FREQ. = 50.00Hz				
VL-PE=231V		VL-N=232V		
L-PE	STD			
<b>FUNC</b>	MODE			

8. Press the **SAVE** key to store the test result in the instrument's memory (see § 7.1) or the **ESC/MENU** key to exit the screen without saving and go back to the main measuring screen.

#### 6.7.4. Br.Cap mode – Verification of the breaking capacity of protection devices

- Press the **MENU** key, move the cursor to **LOOP** in the main menu by means of the arrow keys (**▲**, **▼**) and confirm with **ENTER**. Subsequently, the instrument displays a screen similar to the one reported here to the side **in case of single-phase L-N-PE electrical system selected (see § 5.1.3). For split-phase L-L-PE systems the voltages indicated change in VL1-PE and VL1-L2**. Select “Europe” as a country (see § 5.1.2), the options “TN, TN or IT”, “25 or 50V”, “50Hz or 60Hz” and the reference voltage in the general settings of the instrument (see § 5.1.3).

LOOP		15/10 – 18:04		
TN				
$I_{psc}^{max}$	=	---	A	
ZL-L	=	---	$\Omega$	
FREQ. = 50.00Hz				
VL-PE=0V		VL-L=0V		
L-L	Br.Cap	15kA		
<b>FUNC</b>	<b>MODE</b>	Lim		

- Use the **◀**, **▶** keys to select the parameter to be modified, and the **▲**, **▼** keys to modify the parameter value.
  - **FUNC** → the virtual key allows setting the measuring mode of the instrument, which may be: **L-N**, **L-L** or **L-PE** (single-phase/three-phase systems) or **L1-PE**, **L1-L2** (split-phase systems)
  - **MODE** → the virtual key allows setting the instrument’s operating mode. Select the **Br.Cap** option.
  - **Lim** → the virtual key allows setting the maximum tripping current, expressed in "kA", at which the protection must break the circuit, in the range: **0.1kA ÷ 999kA**.
- If possible, disconnect all loads connected downstream of the point to be measured, as the impedance of these users could distort the test results. Perform the preliminary calibration of the test leads as described in § 6.7.2
- Insert the green, blue and black connectors of the three-pin plug cable into the corresponding inputs B3, B4 and B1 of the instrument. As an alternative, use the single cables and apply the relevant alligator clips to the free ends of the cables. It is also possible to use the remote switch probe by inserting its multipolar connector into the input B1. Connect the Mains Plug, the alligator clips or the remote switch probe to the electrical mains according to Fig. 25, Fig. 26, Fig. 27, Fig. 28 or Fig. 29, Fig. 30, Fig. 31, Fig. 32, Fig. 33 or Fig. 34

- Note the presence of the correct voltage values between L-L and L-PE corresponding to the selections carried out in the initial phase (see § 5.1.3) as shown in the screen to the side.

LOOP		15/10 – 18:04		
TN				
$I_{psc}^{max}$	=	---	A	
ZL-L	=	---	$\Omega$	
FREQ. = 50.00Hz				
VL-PE=223V		VL-L=387V		
L-L	Br.Cap	15kA		
<b>FUNC</b>	<b>MODE</b>	Lim		

6. Press the **GO/STOP** key on the instrument, the **START** key on the remote switch probe or use the AutoStart feature (see § 5.1.5). The instrument starts the measurement and the “**Measuring...**” message is shown at display. During this whole stage, do not disconnect the measuring leads of the instrument from the system under test. The following screen appears on the instrument's display.

LOOP	15/10 – 18:04	■	
TN		▶◀	
$I_{psc}^{max}$	= ---	A	
ZL-L	= ---	$\Omega$	
FREQ. = 50.00Hz			
VL-PE=223V		VL-L=387V	
<b>Measuring...</b>			
L-L	Br.Cap	15kA	
<b>FUNC</b>	<b>MODE</b>	Lim	

7. In case of **positive** result ( $I_{pscMAX} < Lim$ ), the “**OK**” outcome message is shown on the display.

LOOP	15/10 – 18:04	■	
TN		▶◀	
$I_{psc}^{max}$	= 3019	A	
ZL-L	= 0.16	$\Omega$	
FREQ. = 50.00Hz			
VL-PE=223V		VL-L=387V	
<b>OK</b>			
L-L	Br.Cap	6.0kA	
<b>FUNC</b>	<b>MODE</b>	Lim	

8. In case of **negative** result ( $I_{pscMAX} > Lim$ ), the “**NOT OK**” outcome message is shown on the display.

LOOP	15/10 – 18:04	■	
TN		▶◀	
$I_{psc}^{max}$	= 7236	A	
ZL-L	= 0.07	$\Omega$	
FREQ. = 50.00Hz			
VL-PE=223V		VL-L=387V	
<b>NOT OK</b>			
L-L	Br.Cap	6.0kA	
<b>FUNC</b>	<b>MODE</b>	Lim	

9. Press the **SAVE** key to store the test result in the instrument's memory (see § 7.1) or the **ESC/MENU** key to exit the screen without saving and go back to the main measuring screen.

### 6.7.5. TripT - Verification of protection coordination

- Press the **MENU** key, move the cursor to **LOOP** in the main menu by means of the arrow keys (**▲**, **▼**) and confirm with **ENTER**. Subsequently, the instrument displays a screen similar to the one reported here to the side **in case of single-phase L-N-PE electrical system selected (see § 5.1.3). For split-phase L-L-PE systems the voltages indicated change in VL1-PE and VL1-L2**. Select “Europe” as a country (see § 5.1.2), the options “TN, TN or IT”, “25 or 50V”, “50Hz or 60Hz” and the reference voltage in the general settings of the instrument (see § 5.1.3).

LOOP		15/10 – 18:04		■	
TN					
$I_{psc}^{min}$	=	---		A	
ZL-L	=	---		$\Omega$	
FREQ. = 0.00Hz					
VL-PE=0V			VL-L=0V		
L-L	TripT	16A	0.2s		
<b>FUNC</b>	<b>MODE</b>	<b>MCB-C</b>	<b>Time</b>		

**NOTE: for countries different from “Europe”, the MCB and Fuse reference type can be changed.**

- Use the **◀**, **▶** keys to select the parameter to be modified, and the **▲**, **▼** keys to modify the parameter value.
  - **FUNC** → the virtual key allows setting the measuring mode of the instrument, which may be: **L-N**, **L-L** or **L-PE** (single-phase/three-phase systems) or **L1-PE**, **L1-L2** (split-phase systems)
  - **MODE** → the virtual key allows setting the instrument’s operating mode. Select the **TripT** option.
  - **Type of protection** → the virtual key allows setting the type of protection (**Fuse** of type **gG**, **aM** or magnetothermal **MCB** in curve **B**, **C**, **D**, **K**) and the relevant nominal currents considering the below available values:
    - MCB curve B** → 3A, 6A, 10A, 13A, 15A, 16A, 20A, 25A, 32A, 40A, 45A, 50A, 63A, 80A, 100A, 125A, 160A, 200A
    - MCB curve C** → 0.5A, 1A, 1.6A, 2A, 3A, 4A, 6A, 10A, 13A, 15A, 16A, 20A, 25A, 32A, 40A, 50A, 63A, 80A, 100A, 125A, 160A, 200A
    - MCB curve D, K** → 0.5A, 1A, 1.6A, 2A, 3A, 4A, 6A, 10A, 13A, 15A, 16A, 20A, 25A, 32A, 40A, 45A, 50A, 63A, 80A, 100A, 125A, 160A, 200A
    - Fuse gG** → 2A, 4A, 6A, 8A, 10A, 12A, 13A, 16A, 20A, 25A, 32A, 35A, 40A, 50A, 63A, 80A, 100A, 125A, 160A, 200A, 250A, 315A, 400A, 500A, 630A, 800A, 1000A, 1250A
    - Fuse aM** → 2A, 4A, 6A, 10A, 12A, 16A, 20A, 25A, 32A, 35A, 40A, 50A, 63A, 80A, 100A, 125A, 160A, 200A, 250A, 315A, 400A, 500A, 630A
  - Time** → the virtual key allows setting the protection’s tripping time among the options: **0.1s**, **0.2s**, **0.4s**, **1s**, **5s**

press the **SAVE** key to save the selected parameter and go back to the measurement screen
- If possible, disconnect all loads connected downstream of the point to be measured, as the impedance of these users could distort the test results. Perform the preliminary calibration of the test leads as described in § 6.7.2.
- Insert the green, blue and black connectors of the three-pin plug cable into the corresponding inputs B3, B4 and B1 of the instrument. As an alternative, use the single cables and apply the relevant alligator clips to the free ends of the cables. It is also possible to use the remote switch probe by inserting its multipolar connector into the input B1. Connect the Mains Plug, the alligator clips or the remote switch probe to the electrical mains according to Fig. 25, Fig. 26, Fig. 27, Fig. 28 or Fig. 29, Fig. 30, Fig. 31, Fig. 32, Fig. 33 or Fig. 34

5. Note the presence of the correct voltage values between L-L and L-PE corresponding to the selections carried out in the initial phase (see § 5.1.3) as shown in the screen to the side.

LOOP	15/10 – 18:04	■	
TN		▶◀	
$I_{psc}^{min}$	= ---	A	
ZL-L	= ---	$\Omega$	
FREQ. = 50.00Hz			
VL-PE=223V		VL-L=387V	
L-L	TripT	16A	0.2s
<b>FUNC</b>	MODE	MCB-C	Time

6. Press the **GO/STOP** key on the instrument, the **START** key on the remote switch probe or use the AutoStart feature (see § 5.1.5). The instrument starts the measurement and the “**Measuring...**” message is shown on the display. During this whole stage, do not disconnect the measuring leads of the instrument from the system under test. The following screen appears on the instrument's display.

LOOP	15/10 – 18:04	■	
TN		▶◀	
$I_{psc}^{min}$	= ---	A	
ZL-L	= ---	$\Omega$	
FREQ. = 50.00Hz			
VL-PE=223V		VL-L=387V	
<b>Measuring...</b>			
L-L	TripT	16A	0.2s
<b>FUNC</b>	MODE	MCB-C	Time

7. In case of **positive** result (minimum short-circuit current interrupted by the protection device within the time indicated by the performed selections), the “**OK**” message and the screen to the side are displayed by the instrument.

LOOP	15/10 – 18:04	■	
TN		▶◀	
$I_{psc}^{min}$	= 212	A	
ZL-L	= 1.03	$\Omega$	
FREQ. = 50.00Hz			
VL-PE=223V		VL-L=387V	
<b>OK</b>			
L-L	TripT	16A	0.2s
<b>FUNC</b>	MODE	MCB-C	Time

8. In case of **negative** result (minimum short-circuit current NOT interrupted by the protection device within the time indicated by the performed selections), the “**NOT OK**” message and the screen to the side are displayed by the instrument.

LOOP	15/10 – 18:04	■	
TN		▶◀	
$I_{psc}^{min}$	= 1681	A	
ZL-L	= 0.13	$\Omega$	
FREQ. = 50.00Hz			
VL-PE=223V		VL-L=387V	
<b>NOT OK</b>			
L-L	TripT	16A	0.2s
<b>FUNC</b>	MODE	MCB-C	Time

9. Press the **SAVE** key to store the test result in the instrument's memory (see § 7.1) or the **ESC/MENU** key to exit the screen without saving and go back to the main measuring screen.

### 6.7.6. $R_{a\frac{1}{2}}$ 2-wire test - Verification of protection against indirect contacts

- Press the **MENU** key, move the cursor to **LOOP** in the main menu by means of the arrow keys (**▲**, **▼**) and confirm with **ENTER**. Subsequently, the instrument displays a screen similar to the one reported here to the side **in case of single-phase L-N-PE electrical system selected (see § 5.1.3). For split-phase L-L-PE systems the voltages indicated change in VL1-PE and VL1-L2**Select “Europe” as a country (see § 5.1.2), the options “TN”, “25 or 50V”, “50Hz or 60Hz” and the reference voltage in the general settings of the instrument (see § 5.1.3).

LOOP	15/10 – 18:04	■	
TN			
$I_{pfc}^{min}$	=	---	A
ZL-PE	=	---	$\Omega$
FREQ.	=	0.00Hz	
VL-PE=0V			
$R_{a\frac{1}{2}}$	2Wire	16A	0.2s
<b>FUNC</b>	<b>MODE</b>	<b>MCB-C</b>	<b>Time</b>

**NOTE: for countries different from “Europe”, the MCB and Fuse reference type can be changed.**

- Use the **◀**, **▶** keys to select the parameter to be modified, and the **▲**, **▼** keys to modify the parameter value.
  - **FUNC** → the virtual key allows setting the measuring mode of the instrument, which may be:  $R_{a\frac{1}{2}}$ .
  - **MODE** → the virtual key allows setting the instrument’s operating mode. Select the **2Wire** option.
  - **Type of protection** → the virtual key allows setting the type of protection (**Fuse** of type **gG**, **aM** or magnetothermal **MCB** in curve **B**, **C**, **D**, **K**) and the relevant nominal currents considering the below available values:
    - MCB curve B** → 3A, 6A, 10A, 13A, 15A, 16A, 20A, 25A, 32A, 40A, 45A, 50A, 63A, 80A, 100A, 125A, 160A, 200A
    - MCB curve C** → 0.5A, 1A, 1.6A, 2A, 3A, 4A, 6A, 10A, 13A, 15A, 16A, 20A, 25A, 32A, 40A, 50A, 63A, 80A, 100A, 125A, 160A, 200A
    - MCB curve D, K** → 0.5A, 1A, 1.6A, 2A, 3A, 4A, 6A, 10A, 13A, 15A, 16A, 20A, 25A, 32A, 40A, 45A, 50A, 63A, 80A, 100A, 125A, 160A, 200A
    - Fuse gG** → 2A, 4A, 6A, 8A, 10A, 12A, 13A, 16A, 20A, 25A, 32A, 35A, 40A, 50A, 63A, 80A, 100A, 125A, 160A, 200A, 250A, 315A, 400A, 500A, 630A, 800A, 1000A, 1250A
    - Fuse aM** → 2A, 4A, 6A, 10A, 12A, 16A, 20A, 25A, 32A, 35A, 40A, 50A, 63A, 80A, 100A, 125A, 160A, 200A, 250A, 315A, 400A, 500A, 630A
  - **Time** → the virtual key allows setting the protection’s tripping time among the options: **0.1s**, **0.2s**, **0.4s**, **1s**, **5s**.  
press the **SAVE** key to save the selected parameter and go back to the measurement screen
- If possible, disconnect all loads connected downstream of the point to be measured, as the impedance of these users could distort the test results. Perform the preliminary calibration of the test leads as described in § 6.7.2.
- Insert the green and black connectors of the three-pin plug cable into the corresponding inputs B3 and B1 of the instrument. As an alternative, use the single cables and apply the relevant alligator clips to the free ends of the cables. It is also possible to use the remote switch probe by inserting its multipolar connector into the input B1. Connect the Mains Plug, the alligator clips or the remote switch probe to the electrical mains according to Fig. 31, Fig. 32 or Fig. 33.

5. Note the presence of the correct voltage values between L-PE corresponding to the selections carried out in the initial phase (see § 5.1.3) as shown in the screen to the side.

LOOP	15/10 – 18:04	
TN		
$I_{pfc}^{min}$	= ---	A
ZL-PE	= ---	$\Omega$
FREQ. = 50.00Hz		
VL-PE=223V		
Ra $\ddagger$	2Wire	16A 0.2s
<b>FUNC</b>	MODE	MCB-C Time

6. Press the **GO/STOP** key on the instrument, the **START** key on the remote switch probe or use the AutoStart feature (see § 5.1.5). The instrument starts the measurement and the “**Measuring...**” message is shown at display. During this whole stage, do not disconnect the measuring leads of the instrument from the system under test. The following screen appears on the instrument's display.

LOOP	15/10 – 18:04	
TN		
$I_{pfc}^{min}$	= ---	A
ZL-PE	= ---	$\Omega$
FREQ. = 50.00Hz		
VL-PE=223V		
<b>Measuring...</b>		
Ra $\ddagger$	2Wire	16A 0.2s
<b>FUNC</b>	MODE	MCB-C Time

7. In case of **positive** result ( $Z_{L-PE} \leq$  to limit impedance relative to protection device within the specified time – see § 12.10), the “**OK**” message and the screen to the side are displayed by the instrument.

LOOP	15/10 – 18:04	
TN		
$I_{pfc}^{min}$	= 1213	A
ZL-PE	= 0.18	$\Omega$
FREQ. = 50.00Hz		
VL-PE=223V		
<b>OK</b>		
Ra $\ddagger$	2Wire	16A 0.2s
<b>FUNC</b>	MODE	MCB-C Time

8. In case of **negative** result ( $Z_{L-PE} >$  to limit impedance relative to protection device within the specified time – see § 12.10), the “**NOT OK**” message and the screen to the side are displayed by the instrument.

LOOP	15/10 – 18:04	
TN		
$I_{pfc}^{min}$	= 88	A
ZL-PE	= 2.08	$\Omega$
FREQ. = 50.00Hz		
VL-PE=223V		
<b>NOT OK</b>		
Ra $\ddagger$	2Wire	16A 0.2s
<b>FUNC</b>	MODE	MCB-C Time

9. Press the **SAVE** key to store the test result in the instrument's memory (see § 7.1) or the **ESC/MENU** key to exit the screen without saving and go back to the main measuring screen.

### 6.7.7. $R_{a\ddagger}$ 3-wire test - Verification of protection against indirect contacts

- Press the **MENU** key, move the cursor to **AUTO** in the main menu by means of the arrow keys ( $\blacktriangle$ ,  $\blacktriangledown$ ) and confirm with **ENTER**. Subsequently, the instrument displays a screen similar to the one reported here to the side **in case of single-phase L-N-PE electrical system selected (see § 5.1.3). For split-phase L-L-PE systems the voltages indicated change in VL1-PE and VL1-L2.** Select “Europe” as a country (see § 5.1.2), the options “TN”, “25 or 50V”, “50Hz or 60Hz” and the reference voltage in the general settings of the instrument (see § 5.1.3).

LOOP	15/10 – 18:04		
TN			
Isc=---	A	ZL-N=---	$\Omega$
Ifc=---	A	ZL-PE=---	$\Omega$
FREQ=0.00Hz			
VL-N=0V		VL-PE=0V	
$R_{a\ddagger}$	3Wire	16A	0.2s
<b>FUNC</b>	MODE	MCB-C	Time

**NOTE: for countries different from “Europe”, the MCB and Fuse reference type can be changed.**

- Use the  $\blacktriangleleft$ ,  $\blacktriangleright$  keys to select the parameter to be modified, and the  $\blacktriangle$ ,  $\blacktriangledown$  keys to modify the parameter value.
  - **FUNC** → the virtual key allows setting the measuring mode of the instrument, which may be:  $R_{a\ddagger}$ .
  - **MODE** → the virtual key allows setting the instrument’s operating mode. Select the **3Wire** option.
  - **Type of protection** → the virtual key allows setting the type of protection (**Fuse** of type **gG**, **aM** or magnetothermal **MCB** in curve **B**, **C**, **D**, **K**) and the relevant nominal currents considering the below available values:
    - MCB curve B** → 3A, 6A, 10A, 13A, 15A, 16A, 20A, 25A, 32A, 40A, 45A, 50A, 63A, 80A, 100A, 125A, 160A, 200A
    - MCB curve C** → 0.5A, 1A, 1.6A, 2A, 3A, 4A, 6A, 10A, 13A, 15A, 16A, 20A, 25A, 32A, 40A, 50A, 63A, 80A, 100A, 125A, 160A, 200A
    - MCB curve D, K** → 0.5A, 1A, 1.6A, 2A, 3A, 4A, 6A, 10A, 13A, 15A, 16A, 20A, 25A, 32A, 40A, 45A, 50A, 63A, 80A, 100A, 125A, 160A, 200A
    - Fuse gG** → 2A, 4A, 6A, 8A, 10A, 12A, 13A, 16A, 20A, 25A, 32A, 35A, 40A, 50A, 63A, 80A, 100A, 125A, 160A, 200A, 250A, 315A, 400A, 500A, 630A, 800A, 1000A, 1250A
    - Fuse aM** → 2A, 4A, 6A, 10A, 12A, 16A, 20A, 25A, 32A, 35A, 40A, 50A, 63A, 80A, 100A, 125A, 160A, 200A, 250A, 315A, 400A, 500A, 630A
  - **Time** → the virtual key allows to set type of protection tripping time among the options: **0.1s**, **0.2s**, **0.4s**, **1s**, **5s**

Press **SAVE** key to save the selected parameter and retire to the measurement screen

- If possible, disconnect all loads connected downstream of the point to be measured, as the impedance of these users could distort the test results. Perform the preliminary calibration of the test leads as described in § 6.7.2
- Insert the green, blue and black connectors of the three-pin plug cable into the corresponding inputs B3, B4 and B1 of the instrument. As an alternative, use the single cables and apply the relevant alligator clips to the free ends of the cables. It is also possible to use the remote switch probe by inserting its multipolar connector into the input B1. Connect the Mains Plug, the alligator clips or the remote switch probe to the electrical mains according to Fig. 25, Fig. 26, Fig. 27, Fig. 28 or Fig. 29.

5. Note the correct voltage values between L-N and L-PE as shown in the screen to the side.

AUTO	15/10 – 18:04		
TN			
Isc=---	A	ZL-N=---	Ω
Ifc=---	A	ZL-PE=---	Ω
FREQ=50.00Hz			
VL-N=232V		VL-PE=231V	
Ra $\frac{+}{-}$	3Wire	16A	0.2s
<b>FUNC</b>	MODE	MCB-C	Time

6. Press the **GO/STOP** key on the instrument, the **START** key on the remote switch probe or use the AutoStart feature (see § 5.1.5). The instrument starts the measurement and the “**Measuring...**” message is shown at display. During this whole stage, do not disconnect the measuring leads of the instrument from the system under test. The following screen appears on the instrument's display.

AUTO	15/10 – 18:04		
TN			
Isc=---	A	ZL-N=---	Ω
Ifc=---	A	ZL-PE=---	Ω
FREQ=50.00Hz			
VL-N=232V		VL-PE=231V	
<b>Measuring...</b>			
Ra $\frac{+}{-}$	3Wire	16A	0.2s
<b>FUNC</b>	MODE	MCB-C	Time

7. In case of **positive** result ( $Z_{L-PE} \leq$  to limit impedance relative to protection device within the specified time – see § 12.10), the “**OK**” message and the screen to the side are displayed by the instrument.

AUTO	15/10 – 18:04		
TN			
Isc=1365	A	ZL-N=0.16	Ω
Ifc=1213	A	ZL-PE=0.18	Ω
FREQ=50.00Hz			
VL-N=232V		VL-PE=231V	
<b>OK</b>			
Ra $\frac{+}{-}$	3Wire	16A	0.2s
<b>FUNC</b>	MODE	MCB-C	Time

8. In case of **negative** result ( $Z_{L-PE} >$  to limit impedance relative to protection device within the specified time – see § 12.10), the “**NOT OK**” message and the screen to the side are displayed by the instrument.

AUTO	15/10 – 18:04		
TN			
Isc=89	A	ZL-N=2.06	Ω
Ifc=88	A	ZL-PE=2.08	Ω
FREQ=50.00Hz			
VL-N=232V		VL-PE=231V	
<b>NOT OK</b>			
Ra $\frac{+}{-}$	3Wire	16A	0.2s
<b>FUNC</b>	MODE	MCB-C	Time

9. Press the **SAVE** key to store the test result in the instrument's memory (see § 7.1) or the **ESC/MENU** key to exit the screen without saving and go back to the main measuring screen.

### 6.7.8. Verification of protection against indirect contacts (IT systems)

- Press the **MENU** key, move the cursor to **LOOP** in the main menu by means of the arrow keys (**▲**, **▼**) and confirm with **ENTER**. Subsequently, the instrument displays a screen similar to the one reported here to the side **in case of single-phase L-N-PE electrical system selected (see § 5.1.3). For split-phase L-L-PE systems the voltages indicated change in VL1-PE and VL1-L2.** Select “Europe” as a country (see § 5.1.2), the options “IT”, “25 or 50V”, “50Hz or 60Hz” and the reference voltage in the general settings of the instrument (see § 5.1.3).

LOOP		15/10 – 18:04		■
IT				
Ipfc	=	---	mA	
Ut	=	---	V	
FREQ. = 0.00Hz				
VL-PE=0V		VL-N=0V		
L-PE		Ut		
<b>FUNC</b>	MODE			
- Use the **◀**, **▶** keys to select the parameter to be modified, and the **▲**, **▼** keys to modify the parameter value:

  - **FUNC** → the virtual key allows setting the measuring mode of the instrument, which may be **L-PE** (single-phase/three-phase systems) or **L1-PE** (split-phase systems)
  - **MODE** → fixed Ut limit set by the user (see § 5.1.2).
- If possible, disconnect all loads connected downstream of the point to be measured, as the impedance of these users could distort the test results. Perform the preliminary calibration of the test leads as described in § 6.7.2.
- Insert the green, blue and black connectors of the three-pin plug cable into the corresponding inputs B3, B4 and B1 of the instrument. As an alternative, use the single cables and apply the relevant alligator clips to the free ends of the cables. It is also possible to use the remote switch probe by inserting its multipolar connector into the input B1. Connect the mains plug, the alligator clips or the remote switch probe to the electrical mains according to Fig. 30.
- Note the correct voltage values between L-N and L-PE as shown in the screen to the side.

LOOP		15/10 – 18:04		■
IT				
Ipfc	=	---	mA	
Ut	=	---	V	
FREQ. = 50.00Hz				
VL-PE=232V		VL-N=234V		
L-PE		Ut		
<b>FUNC</b>	MODE			

- Press the **GO/STOP** key on the instrument, the **START** key on the remote switch probe or use the AutoStart feature (see § 5.1.5). The instrument starts the measurement and the “**Measuring...**” message is shown on the display. During this whole stage, do not disconnect the measuring leads of the instrument from the system under test. The following screen appears on the instrument's display.

LOOP		15/10 – 18:04		■
IT				
Ipfc	=	---	mA	
Ut	=	---	V	
FREQ. = 50.00Hz				
VL-PE=232V		VL-N=234V		
Measuring...				
L-PE		Ut		

7. In case of **positive** result (contact voltage at the point <50V or <25V), the “**OK**” message and the screen to the side are displayed by the instrument. The screen contains the value of the first fault current measured, expressed in **mA** (see § 12.9).

FUNC	MODE		
LOOP	15/10 – 18:04		■
IT			
Ipfc	=	83	mA
Ut	=	1	V
FREQ. = 50.00Hz			
VL-PE=232V		VL-N=234V	
<b>OK</b>			
L-PE	Ut		
FUNC	MODE		

8. In case of **negative** result (contact voltage at the point >50V or >25V), the “**NOT OK**” message and the screen to the side are displayed by the instrument.

FUNC	MODE		
LOOP	15/10 – 18:04		■
IT			
Ipfc	=	>999	mA
Ut	=	>50	V
FREQ. = 50.00Hz			
VL-PE=232V		VL-N=234V	
<b>NOT OK</b>			
L-PE	Ut		
FUNC	MODE		

9. Press the **SAVE** key to store the test result in the instrument’s memory (see § 7.1) or the **ESC/MENU** key to exit the screen without saving and go back to the main measuring screen.

### 6.7.9. Verification of protection against indirect contacts (TT systems)

- Press the **MENU** key, move the cursor to **LOOP** in the main menu by means of the arrow keys (**▲**, **▼**) and confirm with **ENTER**. Subsequently, the instrument displays a screen similar to the one reported here to the side **in case of single-phase L-N-PE electrical system selected (see § 5.1.3). For split-phase L-L-PE systems the voltages indicated change in VL1-PE and VL1-L2.** Select “Europe” as a country (see § 5.1.2), the options “TT”, “25 or 50V”, “50Hz or 60Hz” and the reference voltage in the general settings of the instrument (see § 5.1.3).

LOOP		15/10 – 18:04		
TT				
R <sub>A</sub>	=	---	Ω	
U <sub>t</sub>	=	---	V	
FREQ. = 0.00Hz				
VL-PE=0V				
Ra $\ddagger$	2Wire	30mA		
<b>FUNC</b>	MODE	I $\Delta$ n		

- Use the **◀**, **▶** keys to select the parameter to be modified, and the **▲**, **▼** keys to modify the parameter value:
  - **FUNC** → the virtual key allows setting the measuring mode of the instrument, which may be **Ra $\ddagger$**
  - **MODE** → fixed **2-Wire** mode
  - **I $\Delta$ n** → The virtual key allows setting the nominal value of the RCD’s tripping current, which may be: **6mA, 10mA, 30mA, 100mA, 300mA, 500mA, 650mA, 1000mA**
 Press the **SAVE** key to save the selected parameter and go back to the measurement screen.
- If possible, disconnect all loads connected downstream of the point to be measured, as the impedance of these users could distort the test results. Perform the preliminary calibration of the test leads as described in § 6.7.2.
- Insert the green and black connectors of the three-pin plug cable into the corresponding inputs B3 and B1 of the instrument. As an alternative, use the single cables and apply the relevant alligator clips to the free ends of the cables. It is also possible to use the remote switch probe by inserting its multipolar connector into the input B1. Connect the Mains Plug, the alligator clips or the remote switch probe to the electrical mains according to Fig. 31, Fig. 32 or Fig. 33.
- Note the correct voltage values between L-PE as shown in the screen to the side.

LOOP		15/10 – 18:04		
TT				
R <sub>A</sub>	=	---	Ω	
U <sub>t</sub>	=	---	V	
FREQ. = 50.00Hz				
VL-PE=232V				
Ra $\ddagger$	2Wire	30mA		
<b>FUNC</b>	MODE	I $\Delta$ n		

6. Press the **GO/STOP** key on the instrument, the **START** key on the remote switch probe or use the AutoStart feature (see § 5.1.5). The instrument starts the measurement and the “**Measuring...**” message is shown on the display. During this whole stage, do not disconnect the measuring leads of the instrument from the system under test. The following screen appears on the instrument's display.

LOOP	15/10 – 18:04	■	
TT			
R <sub>A</sub>	=	---	Ω
U <sub>t</sub>	=	---	V
FREQ. = 50.00Hz VL-PE=232V			
<b>Measuring...</b>			
Ra $\nabla$	2Wire	30mA	
<b>FUNC</b>	<b>MODE</b>	I $\Delta$ n	

7. In case of **positive** result (**overall earth resistance R<sub>A</sub> < (U<sub>tlim</sub>/I $\Delta$ n)**), the “**OK**” message and the screen to the side are displayed by the instrument. The screen contains the contact voltage value on the secondary display.

LOOP	15/10 – 18:04	■	
TT			
R <sub>A</sub>	=	346	Ω
U <sub>t</sub>	=	10.4	V
FREQ. = 50.00Hz VL-PE=232V			
<b>OK</b>			
Ra $\nabla$	2Wire	30mA	
<b>FUNC</b>	<b>MODE</b>	I $\Delta$ n	

8. In case of **negative** result (**overall earth resistance R<sub>A</sub> > (U<sub>tlim</sub>/I $\Delta$ n)**), the “**NOT OK**” message and the screen to the side are displayed by the instrument. The screen contains the contact voltage value on the secondary display.

LOOP	15/10 – 18:04	■	
TT			
R <sub>A</sub>	=	1765	Ω
U <sub>t</sub>	=	>50	V
FREQ. = 50.00Hz VL-PE=232V			
<b>NOT OK</b>			
Ra $\nabla$	2Wire	30mA	
<b>FUNC</b>	<b>MODE</b>	I $\Delta$ n	

9. Press the **SAVE** key to store the test result in the instrument's memory (see § 7.1) or the **ESC/MENU** key to exit the screen without saving and go back to the main measuring screen.

### 6.7.10. Verification of protection against indirect contacts (TN systems)

9. Press the **MENU** key, move the cursor to **LOOP** in the main menu by means of the arrow keys (**▲**, **▼**) and confirm with **ENTER**. Subsequently, the instrument displays a screen similar to the one reported here to the side **in case of single-phase L-N-PE electrical system selected (see § 5.1.3). For split-phase L-L-PE systems the voltages indicated change in VL1-PE and VL1-L2.** Select “Europe” as a country (see § 5.1.2), the options “TN”, “25 or 50V”, “50Hz or 60Hz” and the reference voltage in the general settings of the instrument (see § 5.1.3).

LOOP		15/10 – 18:04		■	
TN					
$I_{pfc}^{\min}$	=	---	A		
ZL-PE	=	---	$\Omega$		
FREQ. = 0.00Hz					
VL-PE=0V			VL-N=0V		
L-PE	Ut	16A	0.2s		
<b>FUNC</b>	<b>MODE</b>	<b>MCB-C</b>	<b>Time</b>		

**NOTE: for countries different from “Europe”, the MCB and Fuse reference type can be changed.**

10. Use the **◀**, **▶** keys to select the parameter to be modified, and the **▲**, **▼** keys to modify the parameter value
- **FUNC** → the virtual key allows setting the measuring mode of the instrument, which may be **L-PE** (single-phase/three-phase systems) or **L1-PE** (split-phase systems)
  - **MODE** → the virtual key allows setting the instrument’s operating mode. Select the **Ut** option
  - **Type of protection** → the virtual key allows setting the type of protection (**Fuse** of type **gG**, **aM** or magnetothermal **MCB** in curve **B**, **C**, **D**, **K**) and the relevant nominal currents considering the below available values:
    - MCB curve B** → 3A, 6A, 10A, 13A, 15A, 16A, 20A, 25A, 32A, 40A, 45A, 50A, 63A, 80A, 100A, 125A, 160A, 200A
    - MCB curve C** → 0.5A, 1A, 1.6A, 2A, 3A, 4A, 6A, 10A, 13A, 15A, 16A, 20A, 25A, 32A, 40A, 50A, 63A, 80A, 100A, 125A, 160A, 200A
    - MCB curve D, K** → 0.5A, 1A, 1.6A, 2A, 3A, 4A, 6A, 10A, 13A, 15A, 16A, 20A, 25A, 32A, 40A, 45A, 50A, 63A, 80A, 100A, 125A, 160A, 200A
    - Fuse gG** → 2A, 4A, 6A, 8A, 10A, 12A, 13A, 16A, 20A, 25A, 32A, 35A, 40A, 50A, 63A, 80A, 100A, 125A, 160A, 200A, 250A, 315A, 400A, 500A, 630A, 800A, 1000A, 1250A
    - Fuse aM** → 2A, 4A, 6A, 10A, 12A, 16A, 20A, 25A, 32A, 35A, 40A, 50A, 63A, 80A, 100A, 125A, 160A, 200A, 250A, 315A, 400A, 500A, 630A
  - **Time** → the virtual key allows setting the protection’s tripping time among the options: **0.1s**, **0.2s**, **0.4s**, **1s**, **5s**.

Press the **SAVE** key to save the selected parameter and go back to the measurement screen

11. If possible, disconnect all loads connected downstream of the point to be measured, as the impedance of these users could distort the test results. Perform the preliminary calibration of the test leads as described in § 6.7.2.
12. Insert the green, blue and black connectors of the three-pin plug cable into the corresponding inputs B3, B4 and B1 of the instrument. As an alternative, use the single cables and apply the relevant alligator clips to the free ends of the cables. It is also possible to use the remote switch probe by inserting its multipolar connector into the input B1. Connect the Mains Plug, the alligator clips or the remote switch probe to the electrical mains according to Fig. 25, Fig. 26, Fig. 27, Fig. 28 or Fig. 29

13. Note the presence of the correct voltage values between L-N and L-PE corresponding to the selections carried out in the initial phase (see § 5.1.3) as shown in the screen to the side.

LOOP	15/10 – 18:04	■	
TN		▶◀	
$I_{pfc}^{min}$	= ---	A	
ZL-PE	= ---	$\Omega$	
FREQ. = 50.00Hz			
VL-PE=232V		VL-N=231V	
L-PE	Ut	16A	0.2s
<b>FUNC</b>	MODE	MCB-C	Time

14. Press the **GO/STOP** key on the instrument, the **START** key on the remote switch probe or use the AutoStart feature (see § 5.1.5). The instrument starts the measurement and the “**Measuring...**” message is shown at display. During this whole stage, do not disconnect the measuring leads of the instrument from the system under test. The following screen appears on the instrument's display.

LOOP	15/10 – 18:04	■	
TN		▶◀	
$I_{pfc}^{min}$	= ---	A	
ZL-PE	= ---	$\Omega$	
FREQ. = 50.00Hz			
VL-PE=232V		VL-N=231V	
<b>Measuring...</b>			
L-PE	Ut	16A	0.2s
<b>FUNC</b>	MODE	MCB-C	Time

15. In case of **positive** result (calculated minimum short-circuit current HIGHER than tripping current of the protection device within the specified time – see § 12.6), the “**OK**” message and the screen to the side are displayed by the instrument.

LOOP	15/10 – 18:04	■	
TN		▶◀	
$I_{pfc}^{min}$	= 214	A	
ZL-PE	= 1.03	$\Omega$	
FREQ. = 50.00Hz			
VL-PE=232V		VL-N=231V	
<b>OK</b>			
L-PE	Ut	16A	0.2s
<b>FUNC</b>	MODE	MCB-C	Time

16. In case of **negative** result (calculated minimum short-circuit current LOWER than tripping current of the protection device within the specified time – see § 12.6), the “**NOT OK**” message and the screen to the side are displayed by the instrument.

LOOP	15/10 – 18:04	■	
TN		▶◀	
$I_{pfc}^{min}$	= 1695	A	
ZL-PE	= 0.13	$\Omega$	
FREQ. = 50.00Hz			
VL-PE=232V		VL-N=231V	
<b>NOT OK</b>			
L-PE	Ut	16A	0.2s
<b>FUNC</b>	MODE	MCB-C	Time

17. Press the **SAVE** key to store the test result in the instrument's memory (see § 7.1) or the **ESC/MENU** key to exit the screen without saving and go back to the main measuring screen.

### 6.7.11. Anomalous situations

1. If the instrument detects a frequency higher than the maximum limit (63Hz), it does not carry out the test and displays a screen like the one to the side.

LOOP		15/10 – 18:04		
TN				
Ipfc	=	---	A	
ZL-PE	=	---	$\Omega$	
FREQ. = >63Hz				
VL-PE=0V		VL-N=0V		
<b>Freq. out of range</b>				
L-PE		STD		
<b>FUNC</b>	<b>MODE</b>			

2. If the instrument detects a L-N or L-PE voltage lower than the minimum limit (100V), it does not carry out the test and displays a screen like the one to the side. Check that the system being tested is supplied.

LOOP		15/10 – 18:04		
TN				
Ipfc	=	---	A	
ZL-PE	=	---	$\Omega$	
FREQ. = 50.00Hz				
VL-PE <100V		VL-N <100V		
<b>Voltage &lt;100V</b>				
L-PE		STD		
<b>FUNC</b>	<b>MODE</b>			

3. If the instrument detects a L-N or L-PE voltage higher than the maximum limit (265V), it does not carry out the test and displays a screen like the one to the side. Check the connection of measuring cables.

LOOP		15/10 – 18:04		
TN				
Ipfc	=	---	A	
ZL-PE	=	---	$\Omega$	
FREQ. = 50.00Hz				
VL-PE >265V		VL-N >265V		
<b>Voltage &gt;265V</b>				
L-PE		STD		
<b>FUNC</b>	<b>MODE</b>			

4. If the instrument detects a L-L voltage higher than the maximum limit (460V), it does not carry out the test and displays a screen like the one to the side. Check the connection of measuring cables.

LOOP		15/10 – 18:04		
TN				
Ipfc	=	---	A	
ZL-L	=	---	$\Omega$	
FREQ. = 50.00Hz				
VL-PE=>265V		VL-L=>460V		
<b>Voltage &gt;460V</b>				
L-L		STD		
<b>FUNC</b>	<b>MODE</b>			

5. If the instrument detects a dangerous voltage on PE conductor, it provides the warning screen shown to the side and blocks the execution of the tests. Check the PE conductor and earth connection efficiency.

LOOP	15/10 – 18:04		
TN			
Ipfc	=	---	A
ZL-PE	=	---	$\Omega$
FREQ. = 50.00Hz			
VL-PE= 231V VL-N= 234V			
<b>Voltage on PE</b>			
L-PE	STD		
<b>FUNC</b>	<b>MODE</b>		

6. If the instrument detects the absence of the signal to terminal B4 (neutral conductor), it provides the warning screen shown to the side and blocks the execution of the tests.

LOOP	15/10 – 18:04		
TN			
Ipfc	=	---	A
ZL-PE	=	---	$\Omega$
FREQ. = 50.00Hz			
VL-PE= 231V VL-N= 115V			
<b>Missing N</b>			
L-PE	STD		
<b>FUNC</b>	<b>MODE</b>		

7. If the instrument detects the absence of the signal to terminal B3 (PE conductor), it provides the warning screen shown to the side and blocks the execution of the tests

LOOP	15/10 – 18:04		
TN			
Ipfc	=	---	A
ZL-PE	=	---	$\Omega$
FREQ. = 50.00Hz			
VL-PE= 115V VL-N= 231V			
<b>Missing PE</b>			
L-PE	STD		
<b>FUNC</b>	<b>MODE</b>		

8. If the instrument detects the absence of the signal to terminal B1 (phase conductor), it provides the warning screen shown to the side and blocks the execution of the tests

LOOP	15/10 – 18:04		
TN			
Ipfc	=	---	A
ZL-PE	=	---	$\Omega$
FREQ. = 50.00Hz			
VL-PE= 0V VL-N= 0V			
<b>Missing L</b>			
L-PE	STD		
<b>FUNC</b>	<b>MODE</b>		

9. If the instrument detects that the phase L and neutral N leads are inverted, it does not carry out the test and a screen similar to the one reported to the side is displayed. Rotate the mains plug or check the connection of measuring cables.

LOOP	15/10 – 18:04		
TN			
Ipfc	=	---	A
ZL-PE	=	---	$\Omega$
FREQ. = 50.00Hz			
VL-PE= 1V		VL-N= 231V	
<b>Echange L-N</b>			
L-PE	STD		
<b>FUNC</b>	<b>MODE</b>		

10. If the instrument detects that the phase and PE leads are inverted, it does not carry out the test and a screen similar to the one reported to the side is displayed. Check the connection of measuring cables.

LOOP	15/10 – 18:04		
TN			
Ipfc	=	---	A
ZL-PE	=	---	$\Omega$
FREQ. = 50.00Hz			
VL-PE= 231V		VL-N= 1V	
<b>Echange L-PE</b>			
L-PE	STD		
<b>FUNC</b>	<b>MODE</b>		

11. If the instrument detects a dangerous contact voltage  $U_t$  (above the set limit of 25V or 50V) in the starting pre-test, it provides the warning screen shown to the side and blocks the execution of the tests. Check the PE conductor and earth connection efficiency.

LOOP	15/10 – 18:04		
TT			
R <sub>A</sub>	=	---	$\Omega$
$U_t$	=	---	V
FREQ. = 50.00Hz			
VL-PE= 231V			
<b>Contact Volt. &gt; Lim</b>			
R <sub>a</sub>	2Wire	30mA	
<b>FUNC</b>	<b>MODE</b>	I $\Delta$ n	

12. If the electrical noise between the N and PE conductors is so high that it compromises the uncertainty of the measurement result, the symbol is shown. It is recommended to disconnect all the utilities connected to the line and try the measurement again

LOOP	15/10 – 18:04		
TT			
R <sub>A</sub>	=	2.54	$\Omega$
$U_t$	=	0.1	V
FREQ. = 50.00Hz			
VL-PE=234V			
<b>OK</b>			
R <sub>a</sub>	2Fili	30mA	
<b>FUNZ</b>	<b>MODE</b>	I $\Delta$ n	

## 6.8. LOZ: LINE/LOOP IMPEDANCE WITH HIGH RESOLUTION

This Line/loop impedance measurements with high resolution (0.1mΩ) is performed by using the optional accessory **IMP57** connected to the Master unit through the optical cable/RS-232 C2001 supplied with same accessory. The IMP57 must be directly powered by the mains on which measurements are performed. For detailed information, please refer to the user manual of the accessory IMP57.

Please find below the procedure for the measurement of **STD L-L impedance in TN systems**. The same procedures can be applied to any other case considering what is reported in previous § 6.7.

- Press the **MENU** key, move the cursor to **LoZ** in the main menu by means of the arrow keys (**▲**,**▼**) and confirm with **ENTER**. Subsequently the instrument displays a screen similar to the one reported here to the side in case of single-phase L-N-PE electrical system selected (see § 5.1.3). For split-phase L-L-PE systems the voltages indicated change in VL1-PE and VL1-L2. The “IMP57 not detected” message indicates that the IMP57 accessory is not connected to the instrument or not powered directly by the mains

LoZ	15/10 – 18:04		
TN			
Ipsc	=	---	A
ZL-L	=	---	mΩ
R	=	---	mΩ
X	=	---	mΩ
FREQ.	=	---	Hz
VL-L	=	---	V
IMP57 not detected			
L-L	STD		
FUNC	MODE		

- Connect the IMP57 to the instrument via the cable C2001 and to the powered system via the input terminals **C1**, **C2** and **P1**, **P2** placed on it (see the IMP57 user manual). The following screen appears on the display

LoZ	15/10 – 18:04		
TN			
Ipsc	=	---	A
ZL-L	=	---	mΩ
R	=	---	mΩ
X	=	---	mΩ
FREQ.	=	50.0	Hz
VL-L	=	384	V
L-L	STD		
FUNC	MODE		

- Press the **GO/STOP** key on the instrument to start the test. The following screen is shown on the display (in case of L-L measurement in STD mode). The standard (STD) prospective short-circuit current is shown on the display. The L-L Loop impedance values, in addition to its resistive and reactive components, are shown in the central part of the display, expressed in **mΩ**

LoZ	15/10 – 18:04		
TN			
Ipsc	=	15.3	kA
ZL-L	=	15.0	mΩ
R	=	13.2	mΩ
X	=	7.5	mΩ
FREQ.	=	50.0	Hz
VL-L	=	384	V
L-L	STD		
FUNC	MODE		

- Press the **SAVE** key to store the test result in the instrument’s memory (see § 7.1) or the **ESC/MENU** key to exit the screen without saving and go back to the main measuring screen

### 6.9. 1,2,3: PHASE SEQUENCE AND PHASE CONCORDANCE TEST

This function allows testing the phase sequence and concordance **with 1-wire method** by direct contact with live parts (**not on cables with insulating sheath**).

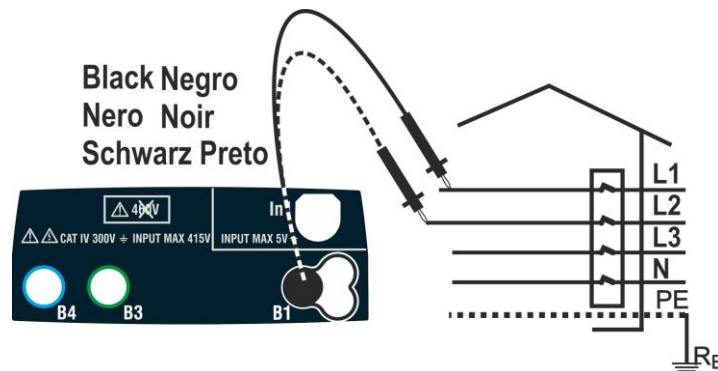

Fig. 35: Phase sequence check with test leads

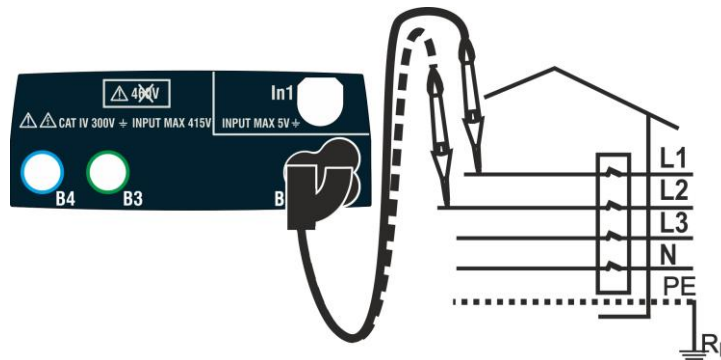
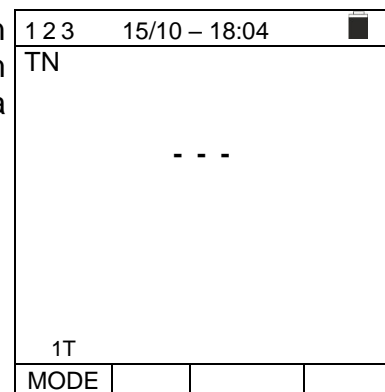

Fig. 36: Phase sequence check with remote switch probe

1. Press the **MENU** key, move the cursor to **123** in the main menu by means of the arrow keys (**▲**, **▼**) and confirm with **ENTER**. Subsequently, the instrument displays a screen similar to the one reported here to the side.



2. Insert the black lead connector into the corresponding input B1 of the instrument. As an alternative, use the single cable and apply the relevant alligator clips to the free ends of the cables. It is also possible to use the remote switch probe by inserting its multipolar connector into the input B1. Connect the alligator clips or the remote switch probe to the electrical mains according to Fig. 35 or Fig. 36.



### CAUTION

- To perform the test it is **necessary** to handle the instrument before carrying out the test in order to have correct mass and voltage frequency references
- De-energize any voltage sources adjacent to the line under test before performing the test

3. Press the **GO/STOP** key on the instrument or the **START** key on the remote switch probe. The instrument will start the test.

The "**Touch L1**" message is shown on the display to indicate that the instrument is waiting to be connected to the L1 phase of the system being tested.

Touch the live part of L1 phase.

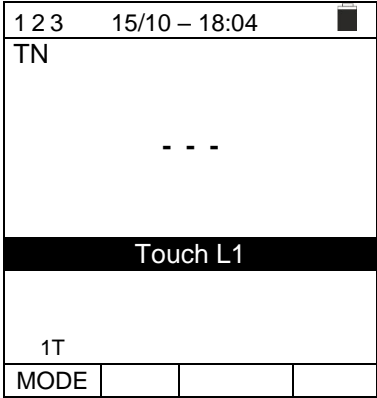

4. The instrument gives out a long sound until input voltage is present. At the end of phase L1 acquisition, the instrument is in standby, waiting for the signal on phase L2, and showing the "**Disconnect L1**" message, as shown in the screen to the side.

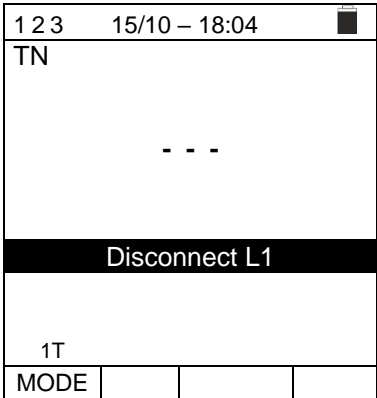

5. Under these conditions, connect the alligator clips, the tips or the remote switch probe to phase L2 in accordance to Fig. 35 or Fig. 36.

The "**Touch L2**" message is shown on the display to indicate that the instrument is waiting to be connected to the L2 phase of the system being tested.

Touch the live part of L2 phase.

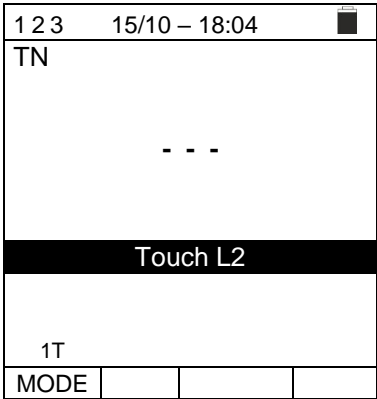

6. The instrument gives out a long sound until input voltage is present. At the end of the test, if the detected phase sequence is correct, the instrument displays a screen like the one shown to the side (result "**123**") and the "**OK**" message.

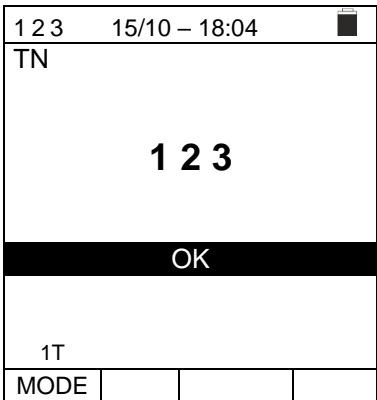

7. At the end of the test, if the detected phase sequence is incorrect, the instrument displays a screen like the one shown to the side (result "213") and the "NOT OK" message.

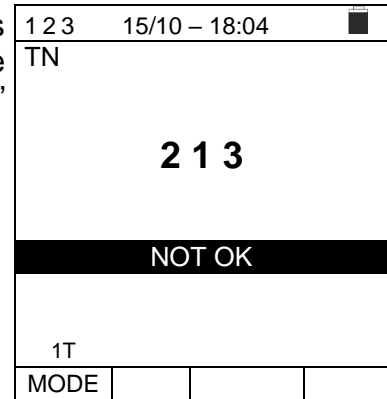

8. At the end of the test, if the two detected voltages are in phase (phase concordance between two distinct three-phase systems), the instrument displays a screen like the one to the side (result "11-") and the "OK" message.

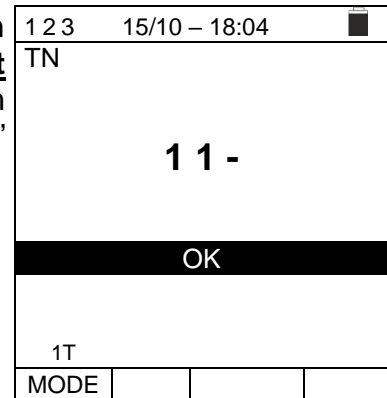

9. Press the **SAVE** key to store the test result in the instrument's memory (see § 7.1) or the **ESC/MENU** key to exit the screen without saving and go back to the main measuring screen.

### 6.9.1. Anomalous situations

1. If the instrument detects an input voltage frequency exceeding the allowed full scale, it will display a screen like the one to the side.

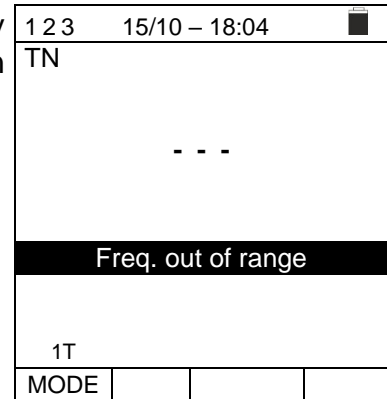

2. If the instrument detects an input L-PE voltage exceeding 265V, it will display a screen like the one to the side.

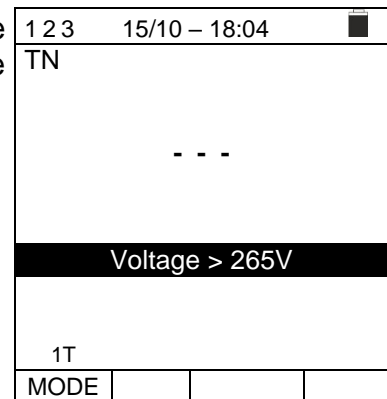

3. If, between the test start and the acquisition of the first voltage or between the acquisition of the first and second voltage, a time longer than approx. 10s has elapsed, the instrument displays a screen like the one to the side. It is necessary to repeat the test.

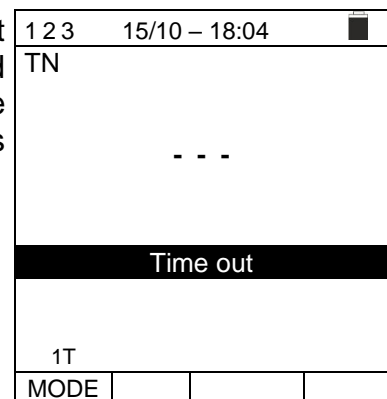

### 6.10. LEAK: LEAKAGE CURRENT MEASUREMENT

This function allows measuring leakage current by means of an external clamp (optional accessory HT96U) or measuring AC TRMS current by using other transducers connected to input In1.

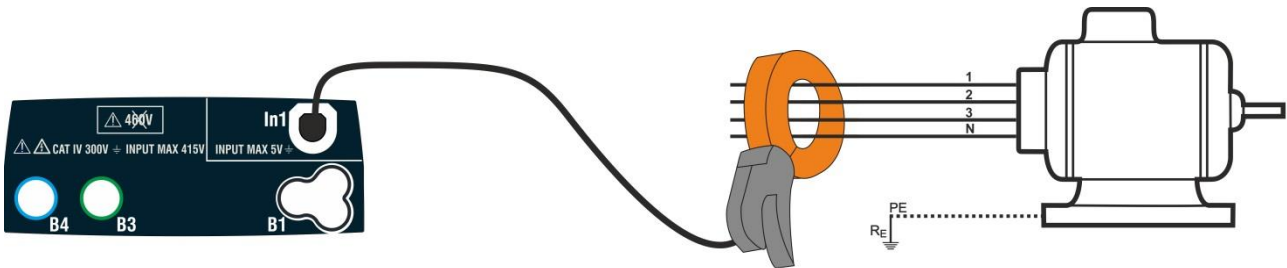

Fig. 37: Indirect measurement of leakage current in three-phase systems

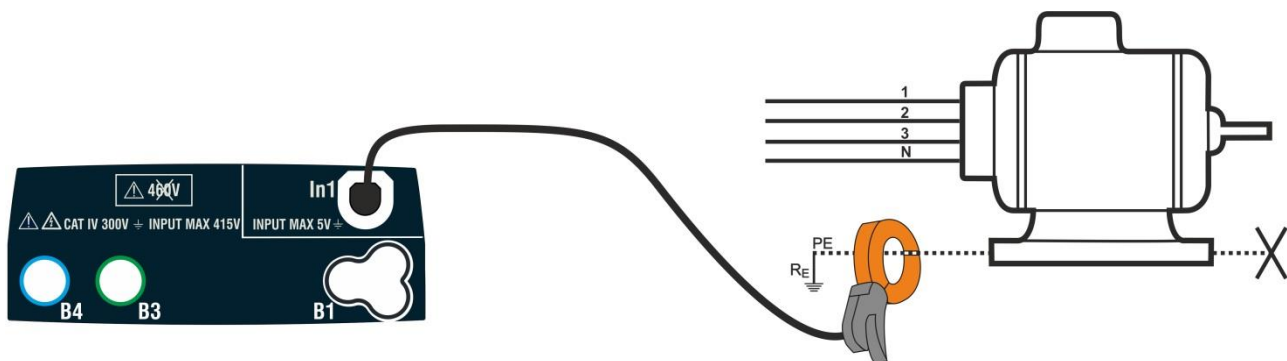

Fig. 38: Direct measurement of leakage current in three-phase systems

1. Press the **MENU** key, move the cursor to **LEAK** in the main menu by means of the arrow keys (**▲**, **▼**) and confirm with **ENTER**. Subsequently, the instrument shows a screen similar to the one on the side. It shows:
  - MAX → maximum value of current detected during the whole measuring time
  - Current measured in real time
  - Date/time of the maximum current value detected while measuring

LEAK 15/10 – 18:04			
MAX = - - - mA			
- - - mA			
- - / -	- / -	- -   - -	
-		- -	
1A	30mA		
FS	Lim.		

2. Use the arrow keys **◀**, **▶** to select the parameter to be modified, and keys **▲**, **▼** to change the parameter's value:
  - **FS** → This key allows setting the full scale of the clamp transducer connected to input In1. The following values can be selected: **1A, 5A, 10A, 30A, 40A, 100A, 200A, 300A, 400A, 1000A, 2000A, 3000A**
  - **Lim** → This key allows selecting the limit threshold for the measurement of the maximum value of current according to the used clamp's FS, which also defines its resolution, to be considered positive.
3. Connect the external clamp to the instrument's input In1
4. For indirect measurements of leakage current, connect the external clamp according to Fig. 37. For direct measurements of leakage current, connect the external clamp according to Fig. 38 and disconnect possible additional earth connections which could influence the test results.

**CAUTION**



Possible additional earth connections could influence the measured value. In case of real difficulty in removing them, we recommend performing the measurement in an indirect way.

5. Press the **GO/STOP** key to start measurement. The instrument shows the message "**Measuring...**" on the display and continuously, in real time, the values of current, and the maximum value detected, which is constantly updated. Press the **GO/STOP** key again to stop measurement. The message "**OK**" appears in case of **positive** result (the maximum value of current is lower than the set limit threshold), further to the indication of the date/time in which the maximum value was detected.

LEAK		15/10 – 18:04	■
MAX	=	12	mA
		1	mA
15/10/21		6:04:35 PM	
<b>OK</b>			
1A	30mA		
<b>FS</b>	Lim.		

6. The message "**NO OK**" appears in case of **negative** result (the maximum value of current is higher than the set limit threshold), further to the indication of the date/time in which the maximum value was detected.

LEAK		15/10 – 18:04	■
MAX	=	52	mA
		1	mA
15/10/21		6:04:35 PM	
<b>NO OK</b>			
1A	30mA		
<b>FS</b>	Lim.		

7. Press the **SAVE** key to store the test result in the instrument's memory (see § 7.1) or the **ESC/MENU** key to exit the screen without saving and go back to the main menu

### 6.11. AUX: MEASURE ENVIRONMENTAL PARAMETERS WITH EXTERNAL PROBES

By means of external probes, this function allows measuring the following environmental parameters:

- °C air temperature in °C (through optional probe **HT52/05**)
- °F air temperature in °F (through optional probe **HT52/05**)
- RH% relative humidity of air (through optional probe **HT52/05**)
- **Lux(20)** illuminance of white-light sources and coloured sources with a capacity of 20Lux (through luxmetric probe **HT53L/05**)
- **Lux(2k)** illuminance of white-light sources and coloured sources with a capacity of 2kLux (through luxmetric probe **HT53L/05**)
- **Lux(20k)** illuminance of white-light sources and coloured sources with a capacity of 20kLux (through luxmetric probe **HT53L/05**)
- **mV** DC input voltage up to 1V (without applying any transduction constant)

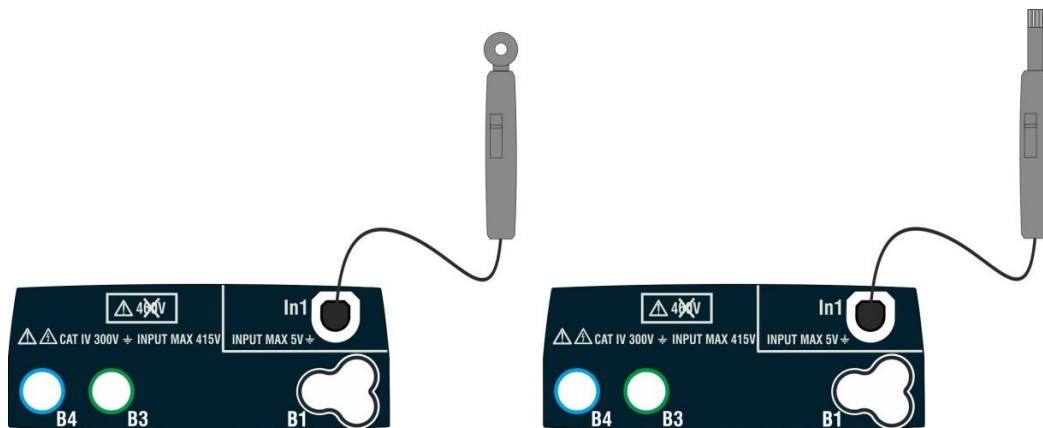
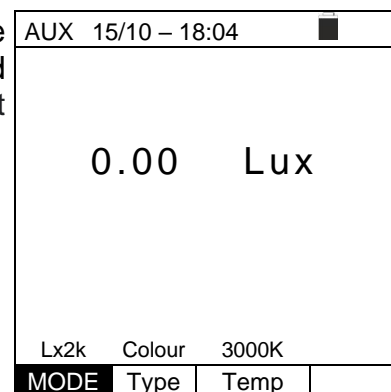

Fig. 39: Measurement of environmental parameters through external probes

1. Press the **MENU** key, move the cursor to **AUX** in the main menu by means of the arrow keys (**▲**, **▼**) and confirm with **ENTER**. Subsequently, the instrument shows a screen similar to the one on the side.



2. Use the arrow keys **◀**, **▶** to select the parameter to be modified, and keys **▲**, **▼** to change the parameter's value:
  - **MODE** → This key allows setting the type of test. Following options are available: °C, °F, %RH, Lx20, Lx2k, Lx20k, mV
  - **Type** → This key allows selecting, in modes **Lx20**, **Lx2k** and **Lx20k**, the type of light source. Following options are available: **White** (white light source) or **Colour** (coloured light source)
  - **Temp** → only in modes **Lx20**, **Lx2k** and **Lx20k** and with **coloured source**, this key allows setting the colour temperature of the source (expressed in Kelvin) in the range: **2500K ÷ 6500K**
3. Insert into the auxiliary input **In1** the probe necessary for the desired measurement, as shown in Fig. 39.

4. The measured value appears on the display in real time as shown in the screen on the side.

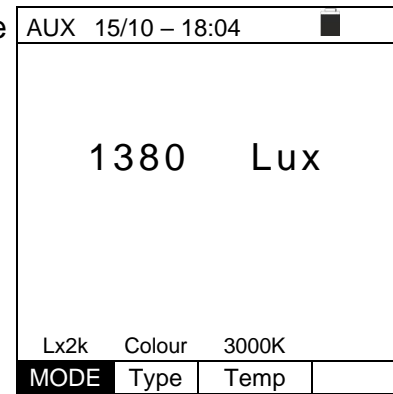

5. Press the **SAVE** key to store the test result in the instrument's memory (see § 7.1) or the **ESC/MENU** key to exit the screen without saving and go back to the main menu

### 6.12. $\Delta V\%$ : VOLTAGE DROP OF MAINS

This feature allows evaluating the percentage value of voltage drop between two points of mains in which a protection device is installed and comparing this value to possible limit values specified by guidelines. The following modes are available:

- **L-N** Measurement of Phase to Neutral line impedance. The test can be performed also with high resolution (0.1m $\Omega$ ) with optional accessory IMP57
- **L-L** Measurement of Phase to Phase line impedance (**L1-L2 for split-phase systems**).. The test can be performed also with high resolution (0.1m $\Omega$ ) with optional accessory IMP57

#### CAUTION



The measurement of line impedance or fault loop impedance involves the circulation of a maximum current according to the technical specifications of the instrument (see § 10.1). This could cause the tripping of possible magnetothermal or differential protections at lower tripping currents.

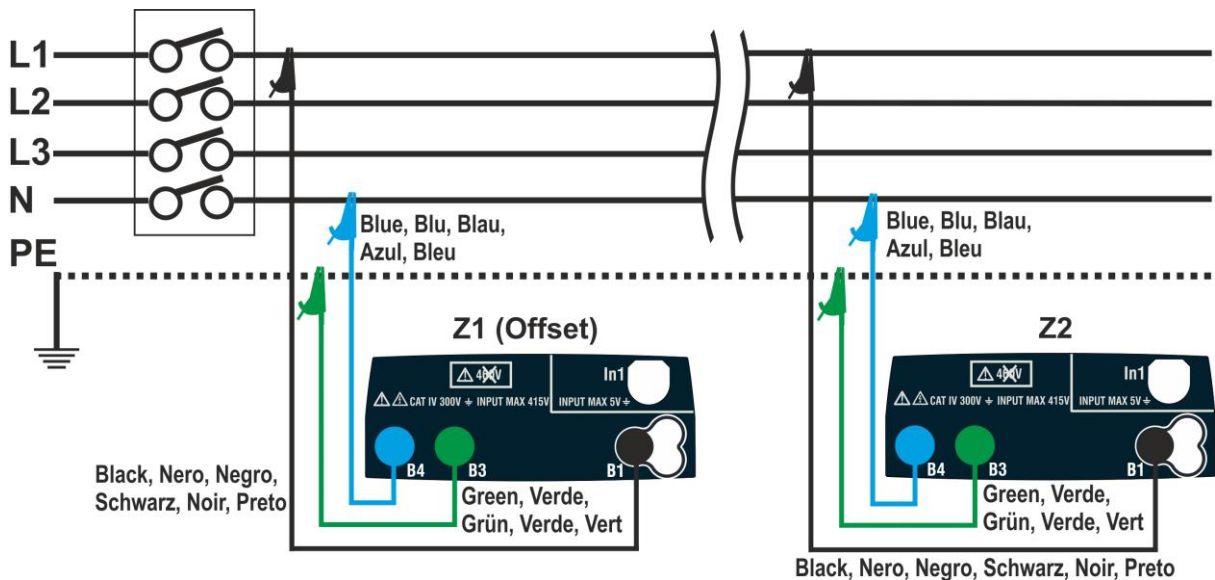

Fig. 40: Connection of the instrument for L-N mode voltage drop measurement

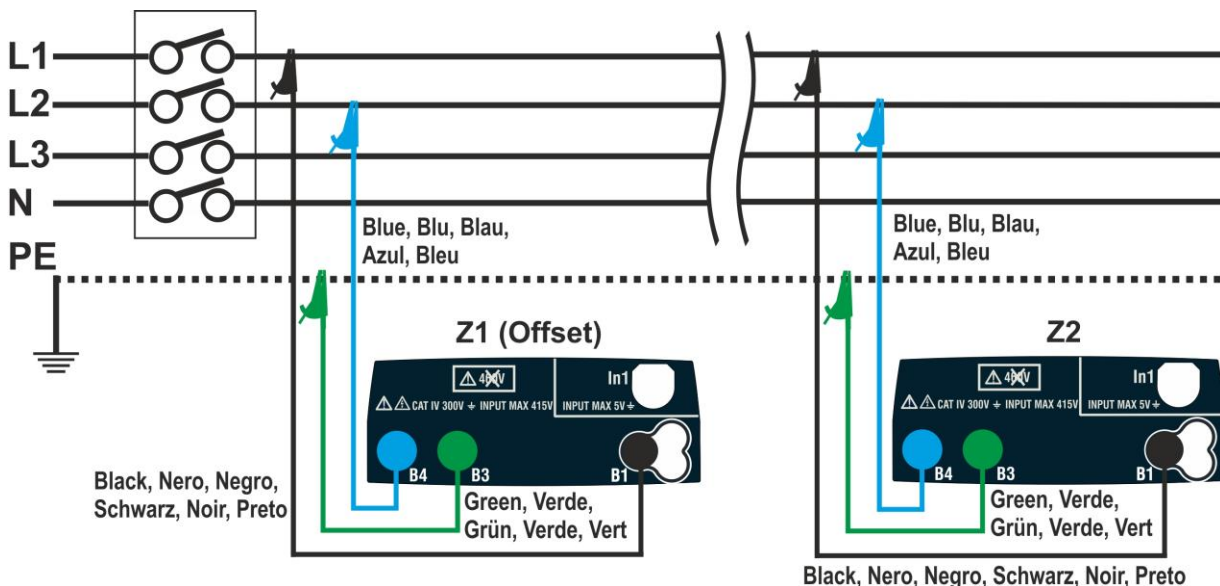

Fig. 41: Connection of the instrument for L-L mode voltage drop measurement

- Press the **MENU** key, move the cursor to  $\Delta V\%$  in the main menu by means of the arrow keys ( $\blacktriangle$ ,  $\blacktriangledown$ ) and confirm with **ENTER**. Subsequently, the instrument displays a screen similar to the one reported here to the side.

$\Delta V\%$	15/10 – 18:04	■	
$\Delta V\%$	=	---	%
ZL-N	=	---	$\Omega$
FREQ. = 0.00 Hz			
VL-PE= 0 V		VL-N= 0 V	
L-N	16A	4%	0.00 $\Omega$
<b>MODE</b>	Inom	Lim.	Z> $\phi$ <

- Use the  $\blacktriangleleft$ ,  $\blacktriangleright$  keys to select the parameter to be modified, and the  $\blacktriangle$ ,  $\blacktriangledown$  keys to modify the parameter value:

- **MODE** → this virtual key allows setting the test mode. The following options are available: **L-N**, **L-L**, **L1-L2**, **CAL**.
- **Inom** → this virtual key allows setting the value of rated current of protection device in the range **1A** to **999A** in steps of **1A**.
- **Lim** → this virtual key allows setting the maximum allowed limit value of voltage drop ( $\Delta V\%$ ) for the mains being tested.
- **Z> $\phi$ <** → this position allows performing the first **Z1(Offset)** impedance measurement. In this case, the instrument will measure the zeroed impedance upstream of the initial point of the mains being tested, taking it as a starting reference.

- Select the **CAL** mode by means of the arrow keys  $\blacktriangle$ ,  $\blacktriangledown$  and perform the calibration of the test cables or of the cable with mains plug by using the **ZEROLOOP** accessory before performing the test (see § 6.7.2).

- Connect the instrument to the initial point of the mains being tested (typically downstream of a protection device) according to Fig. 40 or Fig. 41 in order to carry out the first **Z1 (Offset)** impedance measurement. In this case, the instrument will measure the impedance upstream of the initial point of the mains being tested, taking it as starting reference. The following screen (referred to L-L measurement) appears on the display.

- Use the  $\blacktriangleleft$ ,  $\blacktriangleright$  keys and move the cursor to the “Z> $\phi$ <” position. Press the **GO/STOP** key on the instrument to start the test. The following screen is shown on the display.

$\Delta V\%$	15/10 – 18:04	■	
$\Delta V\%$	=	---	% $\blacktriangleright\emptyset\blacktriangleleft$
ZL-L	=	---	$\Omega$
FREQ. = 50.00 Hz			
VL-PE= 223V		VL-L= 387V	
L-L	16A	4%	0.00 $\Omega$
<b>MODE</b>	Inom	Lim.	<b>Z&gt; <math>\phi</math>&lt;</b>

6. Use the ◀, ▶ keys and move the cursor to the “Z>ϕ<” position. Press the **GO/STOP** key on the instrument to start the test. The result of the Z1(offset ) measurement is shown on the display above the “Z>ϕ<” symbol. If the **Z1(offset) value <10Ω**, the “OK” outcome is shown on the display and is automatically saved in the internal buffer.

ΔV%	15/10 – 18:04			▶◀
ΔV%	=	---	%	▶◀
ZL-L	=	---	Ω	
FREQ. = 50.00 Hz VL-PE= 223V VL-L= 387V				
<b>OK</b>				
L-L	16A	4%	1.48Ω	
MODE	Inom	Lim.	Z>ϕ<	

7. Connect the instrument to the final point of the mains being tested according to Fig. 40 or Fig. 41 in order to measure the **Z2** impedance at the end of the line. Note the previously measured Z1 (Offset) value displayed.

8. **Use the ◀, ▶ keys and move the cursor to any position except “Z>ϕ<”**. Press the **GO/STOP** key on the instrument to measure the Z2 impedance and complete the ΔV% voltage drop measurement. During this whole stage, do not disconnect the measuring leads of the instrument from the system being tested. In case of positive result (**maximum percentage value of calculated voltage drop according to § 12.11 < set limit value**), the “OK” outcome and the screen to the side are displayed by the instrument. The screen contains the value of the **Z2** end-of-line impedance together with the **Z1 (Offset)** value.

ΔV%	15/10 – 18:04			▶◀
ΔV%	=	0.4	%	▶◀
ZL-L	=	1.57	Ω	
FREQ. = 50.00 Hz VL-PE= 223V VL-L= 387V				
<b>OK</b>				
L-L	16A	4%	1.48Ω	
MODE	Inom	Lim.	Z>ϕ<	

9. In case of negative result (**maximum percentage value of calculated voltage drop according to § 12.11 > set limit value**), the “NOT OK” outcome and the screen to the side are displayed by the instrument. The screen contains the value of the **Z2** end-of-line impedance together with the **Z1 (Offset)** value.

ΔV%	15/10 – 18:04			▶◀
ΔV%	=	19.5	%	▶◀
ZL-L	=	5.97	Ω	
FREQ. = 50.00 Hz VL-PE= 223V VL-L= 387V				
<b>NOT OK</b>				
L-L	16A	4%	1.48Ω	
MODE	Inom	Lim.	Z>ϕ<	

10. Press the **SAVE** key to store the test result in the instrument’s memory (see § 7.1) or the **ESC/MENU** key to exit the screen without saving and go back to the main measuring screen.

### 6.12.1. Anomalous situations

1. If the instrument detects a frequency higher than the maximum limit (63Hz), it does not carry out the test and displays a screen like the one to the side.

$\Delta V\%$	15/10 – 18:04	
$\Delta V\%$	= --- %	
ZL-N	= --- $\Omega$	
FREQ. >63 Hz		
VL-PE= 232V VL-N= 232V		
<b>Freq. out of range</b>		
L-N	16A 4% 0.12 $\Omega$	
MODE	Inom	Lim. Z> $\phi$ <

2. If the instrument detects a L-N or L-PE voltage lower than the minimum limit (100V), it does not carry out the test and displays a screen like the one to the side. Check that the system being tested is supplied.

$\Delta V\%$	15/10 – 18:04	
$\Delta V\%$	= --- %	
ZL-N	= --- $\Omega$	
FREQ.= 50.00 Hz		
VL-PE <100V VL-N<100V		
<b>Voltage &lt;100V</b>		
L-N	16A 4% 0.12 $\Omega$	
MODE	Inom	Lim. Z> $\phi$ <

3. If the instrument detects an L-L voltage higher than the maximum limit (460V), it does not carry out the test and displays a screen like the one to the side. Check the connection of measuring cables.

$\Delta V\%$	15/10 – 18:04	
$\Delta V\%$	= --- %	
ZL-N	= --- $\Omega$	
FREQ.= 50.00 Hz		
VL-PE= 242V VL-L >460V		
<b>Voltage &gt;460V</b>		
L-L	16A 4% 0.12 $\Omega$	
MODE	Inom	Lim. Z> $\phi$ <

4. If the instrument detects a L-N or L-PE voltage higher than the maximum limit (265V), it does not carry out the test and displays a screen like the one to the side. Check the connection of measuring cables.

$\Delta V\%$	15/10 – 18:04	
$\Delta V\%$	= --- %	
ZL-N	= --- $\Omega$	
FREQ.= 50.00 Hz		
VL-PE >265V VL-N >265V		
<b>Voltage &gt;265V</b>		
L-N	16A 4% 0.12 $\Omega$	
MODE	Inom	Lim. Z> $\phi$ <

5. If the instrument detects a dangerous voltage on PE conductor, it provides the warning screen shown to the side and blocks the execution of the tests. Check the PE conductor and earth connection efficiency.

$\Delta V\%$	15/10 – 18:04	
$\Delta V\%$	= --- %	
ZL-N	= --- $\Omega$	
FREQ.= 50.00Hz		
VL-PE= 232V VL-N= 232V		
<b>Voltage on PE</b>		
L-N	16A	4% 0.12 $\Omega$
<b>MODE</b>	Inom	Lim. Z> $\phi$ <

6. If the instrument detects the absence of the signal to terminal B1 (phase conductor), it provides the warning screen shown to the side and blocks the execution of the tests.

$\Delta V\%$	15/10 – 18:04	
$\Delta V\%$	= --- %	
ZL-N	= --- $\Omega$	
FREQ.= 50.00Hz		
VL-PE= 0V VL-N= 0V		
<b>Missing L</b>		
L-N	16A	4% 0.12 $\Omega$
<b>MODE</b>	Inom	Lim. Z> $\phi$ <

7. If the instrument detects the absence of the signal to terminal B4 (neutral conductor), it provides the warning screen shown to the side and blocks the execution of the tests.

$\Delta V\%$	15/10 – 18:04	
$\Delta V\%$	= --- %	
ZL-N	= --- $\Omega$	
FREQ.= 50.00Hz		
VL-PE= 232V VL-N= 115V		
<b>Missing N</b>		
L-N	16A	4% 0.12 $\Omega$
<b>MODE</b>	Inom	Lim. Z> $\phi$ <

8. If the instrument detects the absence of the signal to terminal B3 (PE conductor), it provides the warning screen shown to the side and blocks the execution of the tests.

$\Delta V\%$	15/10 – 18:04	
$\Delta V\%$	= --- %	
ZL-N	= --- $\Omega$	
FREQ.= 50.00Hz		
VL-PE= 115V VL-N= 232V		
<b>Missing PE</b>		
L-N	16A	4% 0.12 $\Omega$
<b>MODE</b>	Inom	Lim. Z> $\phi$ <

9. If the instrument detects that the phase L and neutral N leads are inverted, it does not carry out the test and a screen similar to the one reported to the side is displayed. Rotate the mains plug or check the connection of measuring cables.

$\Delta V\%$	15/10 – 18:04			
$\Delta V\%$	=	---	%	
ZL-N	=	---	$\Omega$	
FREQ.= 50.00Hz				
VL-PE=	1V	VL-N=	232V	
<b>Exchange L-N</b>				
L-N	16A	4%	0.12 $\Omega$	
<b>MODE</b>	Inom	Lim.	Z> $\phi$ <	

10. If the instrument detects that the phase and PE leads are inverted, it does not carry out the test and a screen similar to the one reported to the side is displayed. Check the connection of measuring cables.

$\Delta V\%$	15/10 – 18:04			
$\Delta V\%$	=	---	%	
ZL-N	=	---	$\Omega$	
FREQ.= 50.00Hz				
VL-PE=	232V	VL-N=	1V	
<b>Exchange L-PE</b>				
L-N	16A	4%	0.12 $\Omega$	
<b>MODE</b>	Inom	Lim.	Z> $\phi$ <	

11. If the instrument detects a VL-PE, VL-N or VN-PE >5V during the test leads' calibration, it does not carry out the test and a screen similar to the one reported to the side is displayed. Check the connection of measuring cables.

$\Delta V\%$	15/10 – 18:04			
RL	=	---	$\Omega$	
RN	=	---	$\Omega$	
RPE	=	---	$\Omega$	
FREQ.= 50.00Hz				
VL-PE=	232V	VL-N=	231V	
<b>V. Input &gt; 5V</b>				
CAL				
<b>MODE</b>				

### 6.13. PQA: MEASURING MAINS PARAMETERS IN SINGLE-PHASE SYSTEMS

This function allows measuring in real time mains voltage and phase current (with optional clamp transducer), the corresponding harmonics and evaluating power and power factor in single-phase systems.

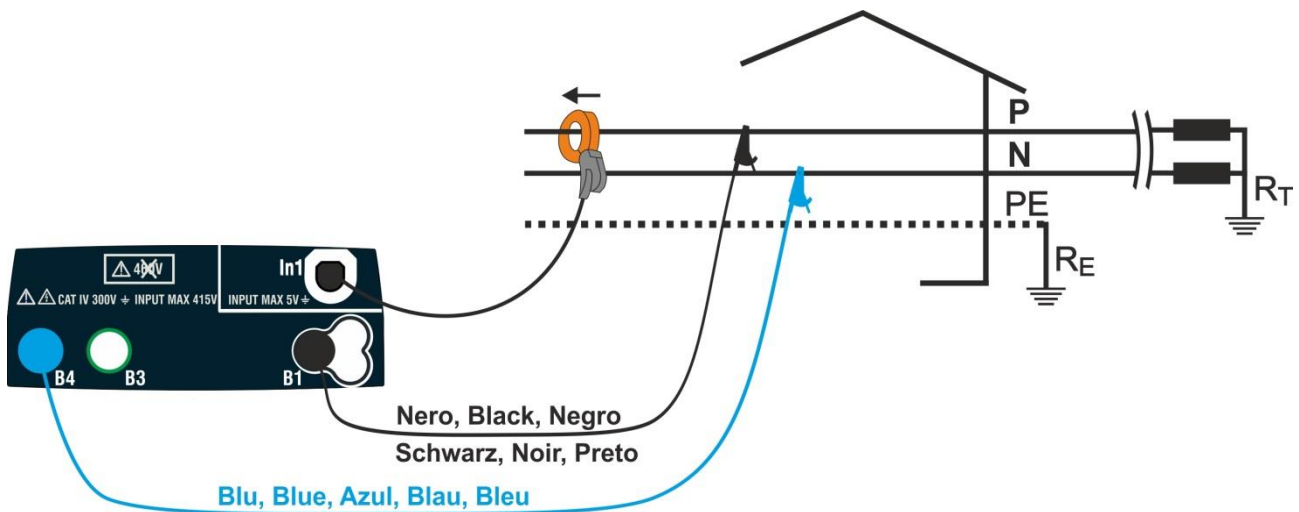

Fig. 42: Connection for measurements in a single-phase system

1. Press the **MENU** key, move the cursor to **PQA** in the main menu by means of the arrow keys (**▲**, **▼**) and confirm with **ENTER**. Subsequently, the instrument shows a screen similar to the one on the side.

PQA 15/10 - 18:04	
V L-N	= 0.0 V
I	= 0.0 A
P	= 0 kW
Q	= 0 kVar
S	= 0 kVA
Pf	= 1.00
Cos φ	= 1.00
Par	100A
<b>MODE</b>	FS

2. Use the arrow keys **◀**, **▶** to select the parameter to be modified, and keys **▲**, **▼** to change the parameter's value:
  - **MODE** → This key allows setting the type of display of the parameters measured by the instrument. Following options are available: **Par** (mains parameters Voltage, Current, active, reactive, apparent Power, Power factor, Cosφ), **ArmV** (Voltage harmonics up to the 25th + THDV%), **Arml** (Current harmonics up to the 25th + THDI%)
  - **FS** → This key allows selecting the full scale (FS) of the clamp transducers which can be used with the instrument. Following values are available: **1A, 5A, 10A, 30A, 40A, 100A, 200A, 300A, 400A, 1000A, 2000A, 3000A**
3. Insert the blue and black connectors of the separate cables into the relevant instrument input terminals B4 and B1. In the free end of the cables, insert the corresponding alligator clips or leads. Connect the alligator clips, leads to phase P and to N according to Fig. 42 to measure voltage in single-phase systems. Connect the external clamp to the instrument's input **In1** and to the phase conductor for single-phase systems. The arrow on the clamp must point in the direction of the current flow, normally from generator to load, as shown in Fig. 42.

4. The screen on the side shows the values of the electric quantities in real time. Symbols “i” and “c” respectively indicate the inductive or capacitive nature of the load.

PQA 15/10 – 18:04	
VL-N =	230.5 V
I =	27.3 A
P =	5.91 kW
Q =	2.15 kVar
S =	6.29 kVA
Pf =	0.94i
Cos φ =	0.94i
Par	100A
<b>MODE</b>	FS

5. Press the **SAVE** key to store the test result in the instrument’s memory (see § 7.1) or the **ESC/MENU** key to exit the screen without saving and go back to the main menu.

6. Use the arrow keys (▲, ▼) in the **MODE** function to select the option “ArmV” (voltage harmonics) or “Arml” (current harmonics). Subsequently, the instrument shows a screen similar to the one on the side, in which the considered amplitude of harmonics is always indicated in a **percentage** value with respect to the fundamental.

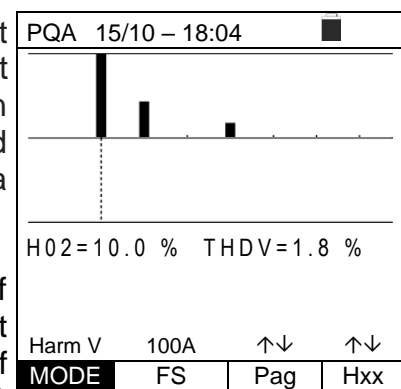

The histogram graphic of the percentage amplitudes of the fundamental and of the voltage VL-N or current harmonics with a **DC value up to the 25th** (the value of the fundamental H01 is always considered equal to 100% and is not shown) further to the value of THD% (see § 12.12) are shown on the display. The following controls are available:

- **Pag** → allows changing the page where harmonics are displayed
- **Hxx** → allows moving the cursor to increase/decrease the harmonic order within the page

7. Press the **SAVE** key to store the test result in the instrument’s memory (see § 7.1) or the **ESC/MENU** key to exit the screen without saving and go back to the main menu

#### 6.14. EVSE: SAFETY CHECKS ON RECHARGING STATIONS FOR ELECTRIC CARS

This function allows carrying out a complete test of electric safety on recharging stations for electric cars (**EVSE** systems – **E**lectrical **V**ehicle **S**upply **E**quipment) by connecting it to the optional adapter **EV-TEST100** via **Type 1** connectors (USA/MEX/JAP countries) or **Type 2** (EU countries), capable of simulating the presence of an electric vehicle, measuring output voltage signals and simulating fault conditions according to the reference standards IEC/EN61851-1 and IEC/EN60364-7-722.



#### CAUTION

- The EVSE test is **NOT** available for IT systems
- The screens shown in the online help are referred to the connection of adapter in single-phase L-N-PE systems

1. Press the **MENU** key, move the cursor to **EVSE** in the main menu by means of the arrow keys (**▲**,**▼**) and confirm with **ENTER**. Subsequently, the instrument shows a screen similar to the one on the side **in case of single-phase L-N-PE electrical system selected (see § 5.1.3). For split-phase L-L-PE systems the voltages indicated change in VL1-PE and VL1-L2.** Select the reference country, the options “TN” or “TT”, “25 or 50V”, “50Hz or 60Hz” and the reference voltage in the general settings of the instrument (see § 5.1.3).

EVSE		15/10 – 18:04		
FREQ	=	0.00	Hz	
VL-N	=	0	V	
VL-PE	=	0	V	
VN-PE	=	0	V	
1Ph	13A	OFF		
Sys	Imax	Vent		

2. Use the keys **◀**, **▶** to select the control parameter, and keys **▲**,**▼** to change the parameter's value:
  - **Sys** → This key allows setting the type of EVSE system among the options: **1ph** (single-phase) and **3Ph** (three-phase)
  - **Imax** → This key allows setting the maximum rated output current of the EVSE system as defined by the reference standard, among the options: **13A**, **20A**, **32A** and **63A**
  - **Vent** → This key allows setting the type of environment in which the EVSE system is found, among the options: **OFF** (non-ventilated), **ON** (ventilated)
  - **Set** → This key allows to manually enable/disable one or more measurements of the EVSE test sequence between the options: **OFF** (test not performed) and **TEST** (test performed)
3. Connect the terminals L1, PE and N of the optional adapter **EV-TEST100** respectively to inputs **B1**, **B3** and **B4** of the instrument, and connect the adapter to the instrument's input **In1** by using the provided cable C100EV depending on the Type 1 or Type 2 connectors (please refer to the user manual of the adapter for further details)
4. Check that there is no voltage among terminals L-N, L-PE and N-PE (single-phase/three-phase L-N-PE systems) or L1-L2, L1-PE, L2-PE (split-phase L-L-PE systems) which indicates that everything is correct in the EVSE system.

Test 1 → Continuity measurement of the protective conductors of the EVSE system

5. Press the **GO/STOP** key to start the sequence of tests. The screen on the side appears on the display. Connect the instrument to the adapter as shown in the displayed diagram (input **B4** to input **E** and input **B1** to the main earth terminal of the system). **Use the three selectors of the adapter and set the following positions:**

- PP State → **NC**
- CP State → **A**
- Fault → **OK**

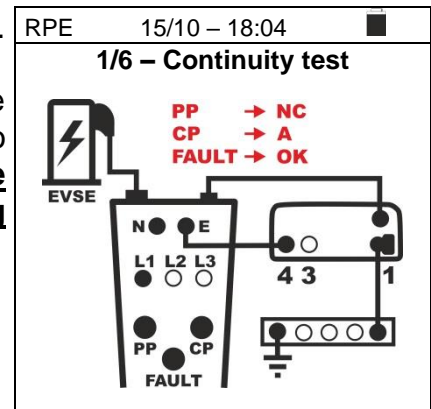

6. Press the **GO/STOP** key. The screen on the side appears on the display. The RPE test is carried out by the instrument **only in STD mode**. Set the limit threshold value and calibrate the test leads as shown in § 6.3.

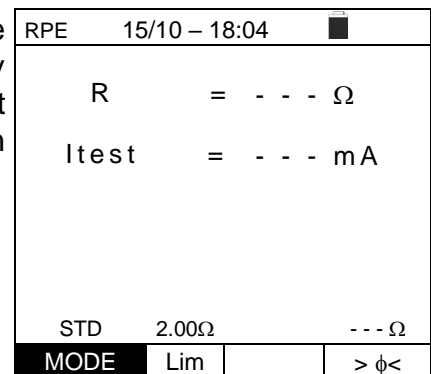

7. Select mode **>φ<** to compensate the resistance of the test leads as indicated in § 6.3.2.

**CAUTION**



- Before connecting the test leads, make sure that there is no voltage at the ends of the conductor to be tested.
- Always make sure, before any measurement, that the compensation resistance value is referred to the cables currently used. In case of doubt, repeat the calibration procedure described in § 6.3.2.

8. Press the **GO/STOP** key. The instrument will start the measurement.

**CAUTION**



The message “**Measuring...**” appears on the display, to indicate that measurement is in progress. During this whole stage, do not disconnect the test leads of the instrument from the system being tested.

9. At the end of measurement, the instrument shows the message “**OK**” in case of a positive result (value lower than the set limit threshold).

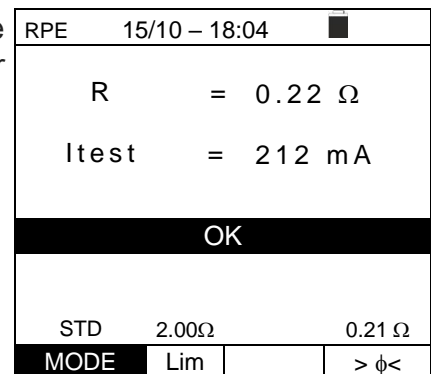

10. Press the **SAVE** key to partially save the test, and to carry on with the subsequent test (no. 13).

11. At the end of the measurement, if the value of the measured resistance is higher than the set limit, the message “**FAIL**” is shown on the display.

RPE	15/10 – 18:04		■
R	=	4.54 Ω	
I <sub>test</sub>	=	212 mA	
<b>FAIL</b>			
STD	2.00Ω	0.21 Ω	
<b>MODE</b>	Lim		> φ<

12. Press the **SAVE** key to partially save the test and to **end the sequence of tests**. The instrument shows the message contained in the following screen for a few seconds.

Repeat the sequence again, if necessary.

RPE	15/10 – 18:04		■
<b>Sequence completed</b>			
STD	2.00Ω	0.21 Ω	
<b>MODE</b>	Lim		> φ<

### Test 2 → Measurement of insulation resistance of the EVSE system

13. Connect the instrument to the adapter as shown in the diagram on the display (input **B4** to input **N**, input **B3** to input **E** and input **B1** to input **L1**). **Use the three selectors of the adapter and set the following positions:**

- PP State → **NC**
- CP State → **A**
- Fault → **OK**

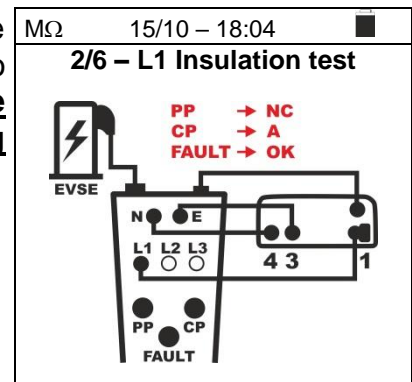

14. Press the **GO/STOP** key. The following screen appears on the display. The test is carried out by the instrument **only in AUTO mode** in a sequence among the conductors L-N, L-PE and N-PE. Please refer to § 6.5 for a description of the setting of the test parameters.

MΩ	15/10 – 18:04		■
RL-N	=	--- MΩ	V <sub>t</sub> = --- V
RL-PE	=	--- MΩ	V <sub>t</sub> = --- V
RN-PE	=	--- MΩ	V <sub>t</sub> = --- V
AUTO	500V	1.00MΩ	
<b>MODE</b>	V <sub>test</sub>	Lim.	

15. **For three-phase EVSE systems**, the following screen appears on the display. The test is carried out by the instrument **only in AUTO mode** in a sequence among the conductors L1-N, L1-PE, L2-N, L2-PE, L3-N, L3-PE and N-PE. Please refer to § 6.5 for a description of the setting of the test parameters.

MΩ	15/10 – 18:04	■	
RL1-N	= --- MΩ	Vt = --- V	
RL1-PE	= --- MΩ	Vt = --- V	
RL2-N	= --- MΩ	Vt = --- V	
RL2-PE	= --- MΩ	Vt = --- V	
RL3-N	= --- MΩ	Vt = --- V	
RL3-PE	= --- MΩ	Vt = --- V	
RN-PE	= --- MΩ	Vt = --- V	
AUTO	500V	1.00MΩ	
<b>MODE</b>	Vtest	Lim.	

16. **For single-phase EVSE systems**, press the **GO/STOP** key on the instrument. The instrument starts the automatic test sequence of insulation resistance among L-N, L-PE and N-PE respectively, and displays the message "**Measuring...**". The instrument displays the message "**OK**" in case of a positive result of every test (value higher than the set minimum threshold).

MΩ	15/10 – 18:04	■	
RL-N	> 999 MΩ	Vt = 523 V	
RL-PE	= 250 MΩ	Vt = 525 V	
RN-PE	> 999 MΩ	Vt = 524 V	
<b>OK</b>			
AUTO	500V	1.00MΩ	
<b>MODE</b>	Vtest	Lim.	

17. **For split-phase EVSE systems**, press the **GO/STOP** key on the instrument. The instrument starts the automatic test sequence of insulation resistance among L1-L2, L1-PE and L2-PE respectively, and displays the message "**Measuring...**". The instrument displays the message "**OK**" in case of a positive result of every test (value higher than the set minimum threshold).

MΩ	15/10 – 18:04	■	
RL1-L2	> 999 MΩ	Vt = 523 V	
RL1-PE	= 250 MΩ	Vt = 525 V	
RL2-PE	> 999 MΩ	Vt = 524 V	
<b>OK</b>			
AUTO	500V	1.00MΩ	
<b>MODE</b>	Vtest	Lim.	

18. Press the **SAVE** key to partially save the test, and to carry on with the subsequent test (no. 27).

19. **For three-phase EVSE systems**, press the **GO/STOP** key on the instrument. The instrument starts the automatic test sequence of insulation resistance between **L1-N** and **L1-PE** respectively, and displays the message "**Measuring...**". The instrument displays the message "**Connect phase L2**" in case of a positive result of the tests (value higher than the set minimum threshold). Press the **SAVE** key to partially save the test, and to carry on with the test on Phase L2. The following screen appears on the display:

MΩ	15/10 – 18:04	■	
RL1-N	> 999 MΩ	Vt = 514 V	
RL1-PE	> 999 MΩ	Vt = 511 V	
RL2-N	= --- MΩ	Vt = --- V	
RL2-PE	= --- MΩ	Vt = --- V	
RL3-N	= --- MΩ	Vt = --- V	
RL3-PE	= --- MΩ	Vt = --- V	
RN-PE	= --- MΩ	Vt = --- V	
<b>Connect phase L2</b>			
AUTO	500V	1.00MΩ	
<b>MODE</b>	Vtest	Lim.	

20. Connect the instrument to the adapter as shown in the diagram on the display (input **B4** to input **N**, input **B3** to input **E** and input **B1** to input **L2**). Use the three selectors of the adapter and set the following positions:

- PP State → **NC**
- CP State → **A**
- Fault → **OK**

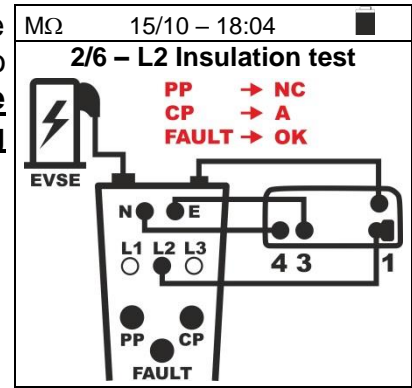

21. Press the **GO/STOP** key on the instrument. The instrument starts the automatic test sequence of insulation resistance between **L2-N** and **L2-PE** respectively, and displays the message "**Measuring...**". The instrument displays the message "**Connect phase L3**" in case of a positive result of the tests (value higher than the set minimum threshold). Press the **SAVE** key to partially save the test, and to carry on with the test on Phase L3. The following screen appears on the display:

MΩ	15/10 - 18:04	
RL1-N	> 999 MΩ	Vt = 514 V
RL1-PE	> 999 MΩ	Vt = 511 V
RL2-N	= 250 MΩ	Vt = 517 V
RL2-PE	> 999 MΩ	Vt = 514 V
RL3-N	= --- MΩ	Vt = --- V
RL3-PE	= --- MΩ	Vt = --- V
RN-PE	= --- MΩ	Vt = --- V
<b>Connect phase L3</b>		
AUTO	500V	1.00MΩ
MODE	Vtest	Lim.

22. Connect the instrument to the adapter as shown in the diagram on the display (input **B4** to input **N**, input **B3** to input **E** and input **B1** to input **L3**). Use the three selectors of the adapter and set the following positions:

- PP State → **NC**
- CP State → **A**
- Fault → **OK**

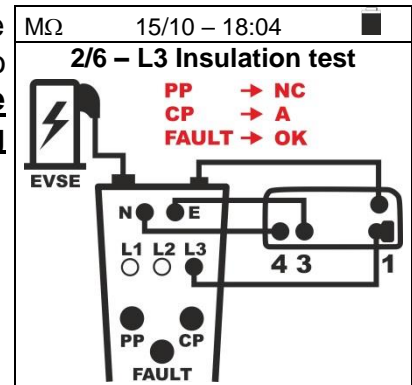

23. Press the **GO/STOP** key on the instrument. The instrument starts the automatic test sequence of insulation resistance among **L3-N**, **L3-PE** and **N-PE** respectively, and displays the message "**Measuring...**". The instrument displays the message "**OK**" in case of a positive result of the tests (value higher than the set minimum threshold).

MΩ	15/10 - 18:04	
RL1-N	> 999 MΩ	Vt = 514 V
RL1-PE	> 999 MΩ	Vt = 511 V
RL2-N	= 250 MΩ	Vt = 517 V
RL2-PE	> 999 MΩ	Vt = 514 V
RL3-N	= --- MΩ	Vt = --- V
RL3-PE	= --- MΩ	Vt = --- V
RN-PE	= --- MΩ	Vt = --- V
<b>OK</b>		
AUTO	500V	1.00MΩ
MODE	Vtest	Lim.

24. Press the **SAVE** key to partially save the test, and to carry on with the subsequent test (no. 26).

25. The instrument displays the message "**FAIL**" in case of a negative result of at least one test (value lower than the set minimum threshold).

MΩ	15/10 – 18:04		
RL-N	= 0.01MΩ	Vt = 523 V	
RL-PE	> 999 MΩ	Vt = 525 V	
RN-PE	> 999 MΩ	Vt = 524 V	
<b>FAIL</b>			
AUTO	500V	1.00MΩ	
<b>MODE</b>	Vtest	Lim.	

26. Press the **SAVE** key to partially save the test and to **end the sequence of tests**. The instrument shows the message contained in the following screen for a few seconds.

Repeat the sequence again, if necessary.

MΩ	15/10 – 18:04		
<b>Sequence completed</b>			
AUTO	500V	1.00MΩ	
<b>MODE</b>	Vtest	Lim.	

**Test 3 → Status check of the EVSE system (single-phase with L-N-PE distribution)**

The purpose of this test (consisting in 6 steps) is checking all internal statuses of the **EVSE** system according to the prescriptions of the reference standards, carrying out simulations with connected accessory **EV-TEST100**. The situations considered are the following:

Status	Select. CP	Select. PP	Select. FAULT	Ventilation	Parameters checked	Result OK	Result NO OK	Result OK*
A	A	NC	OK	ON or OFF	VL1N	≤10V	>10V	-
					VL1-PE	≤10V	>10V	-
					VN-PE	≤10V	>10V	-
					VCP (peak)	12V±0.6V	-	out of range
					Frequency	DC (0Hz)	-	>0Hz
					Charge current	≤0A	-	>0A
B	B	Rated current	OK	ON or OFF	Plug check	Plug blocked	Plug released	-
B	B	Rated current	OK	ON or OFF	VL1N	≤10V	>10V	-
					VL1-PE	≤10V	>10V	-
					VN-PE	≤10V	>10V	-
					VCP (peak)	9V±0.6V	-	out of range
					Frequency	DC (0Hz)	-	>0Hz
					Charge current	≤0A	-	>0A
C	C	Rated current	OK	OFF	VL1N	Vnom±10%	out of range	-
					VL1-PE	Vnom±10%		
					VN-PE	≤25V	>25V	-
					VCP (peak)	6V±0.53V	-	out of range
					Frequency	1kHz±0.5%	-	out of range
					Charge current	Selected current	-	-
D	D	Rated current	OK	ON	VL1N	Vnom±10%	out of range	-
					VL1-PE	Vnom±10%		
					VN-PE	≤25V	>25V	-
					VCP (peak)	3V±0.6V	-	out of range
					Frequency	1kHz±0.5%	-	out of range
					Charge current	Selected current	-	-
FPE	C	Rated current	PE	ON or OFF	VL1N	≤10V	>10V	-
					VL1-PE	≤10V	>10V	-
					VN-PE	≤10V	>10V	-
					VCP (peak)	≤11V	-	>11V
					Frequency	DC (0Hz)	-	>0Hz
					Charge current	≤0A	-	>0A
FE	C	Rated current	E	ON or OFF	VL1N	≤10V	>10V	-
					VL1-PE	≤10V	>10V	-
					VN-PE	≤10V	>10V	-
					VCP (peak)	≤11V	-	>11V
					Frequency	DC (0Hz)	-	>0Hz
					Charge current	≤0A	-	>0A

Table 3: List of considered situations when checking statuses

**Result OK\*** = Test considered positive even if parameter outside the limits

27. Connect the instrument to the adapter as shown in the diagram on the display (input **B4** to input **N**, input **B3** to input **E** and input **B1** to input **L1**). Use the three selectors of the adapter and set the following positions:

- PP State → **NC**
- CP State → **A**
- Fault → **OK**

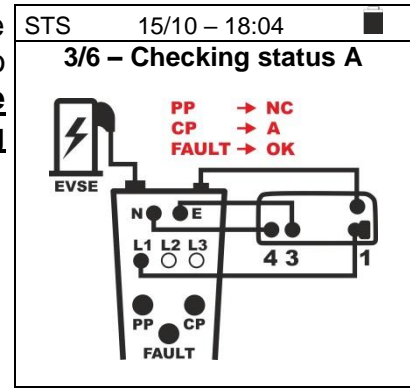

28. Press the **GO/STOP** key. The following screen appears on the display. Notice the presence of the status “**A**” corresponding to the position “STATUS”

STS 15/10 – 18:04	
L1-N = --- V	CP = --- V
L1-PE = --- V	F = --- Hz
N-PE = --- V	I = --- A
A	
STATUS	

29. Press the **GO/STOP** key. The result of measurements is shown in the screen on the side. The instrument displays the message “**OK**” in case of a positive result of the tests (see Table 3)

STS 15/10 – 18:04	
L1-N = 0 V	CP = 12.0 V
L1-PE = 0 V	F = 0 Hz
N-PE = 0 V	I = 0.0 A
<b>OK</b>	
A	
STATUS	

30. Press the **SAVE** key to partially save the test, and to carry on with the subsequent test (no. 33).

31. The instrument displays the message “**FAIL**” in case of a negative result of at least one test (see Table 3)

STS 15/10 – 18:04	
L1-N = 21.5 V	CP = 12.0 V
L1-PE = 0 V	F = 0 Hz
N-PE = 0 V	I = 0.0 A
<b>FAIL</b>	
A	
STATUS	

32. Press the **SAVE** key to partially save the test and to **end the sequence of tests**. The instrument shows the message contained in the following screen for a few seconds.

Repeat the sequence again, if necessary.

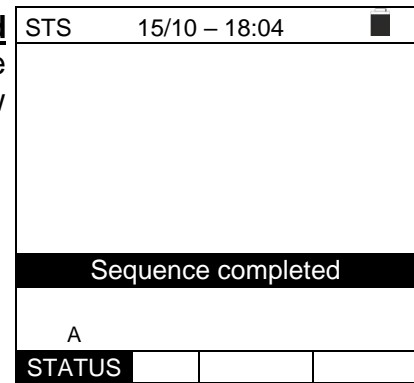

33. Use the three selectors of the adapter and set the following positions:

- PP State → **13A,20A,32A** or **63A**
- CP State → **B**
- Fault → **OK**

Try and remove the connection plug of the adapter EV-TEST100 in order to check whether the EVSE system **correctly blocks it**, as indicated in the screen on the side.

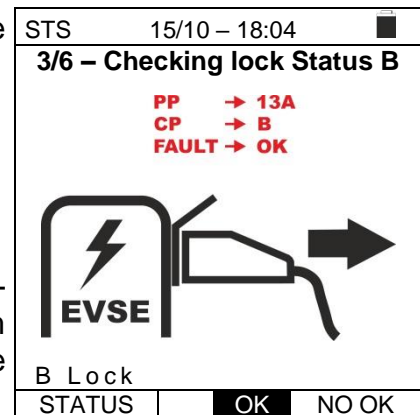

Use the keys ◀, ▶ to select the option "OK" in case of a positive result, and press the **GO/STOP** key to carry on with the test (see no. 35), or select the option "NO OK" and press the **GO/STOP** key **to end the sequence of tests**.

**NOTE: some EVSE stations may not be provided with the mechanical blocking system. In this case, select the option "OK" to carry on with the tests.**

34. Press the **SAVE** key to partially save the test and to **end the sequence of tests**. The instrument shows the message contained in the following screen for a few seconds.

Repeat the sequence again, if necessary.

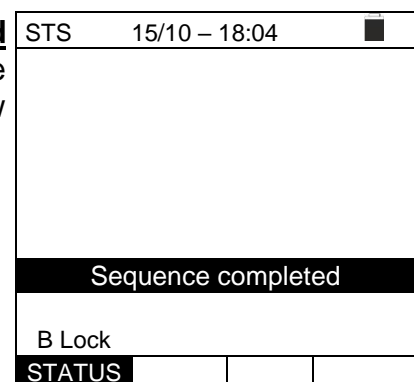

35. Connect the instrument to the adapter as shown in the diagram on the display (input **B4** to input **N**, input **B3** to input **E** and input **B1** to input **L1**). Use the three selectors of the adapter and set the following positions:

- PP State → **13A,20A,32A** or **63A**
- CP State → **B**
- Fault → **OK**

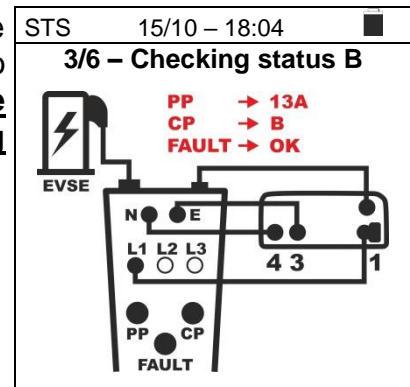

36. Press the **GO/STOP** key. The following screen appears on the display. Notice the presence of the status “**B**” corresponding to the position “STATUS”

STS		15/10 – 18:04	
<b>3/6 – Checking status B</b>			
<p>PP → 13A CP → B FAULT → OK</p>			
L1-N = --- V		CP = --- V	
L1-PE = --- V		F = --- Hz	
N-PE = --- V		I = --- A	
B			
STATUS			

37. Press the **GO/STOP** key. The result of measurements is shown in the screen on the side. The instrument displays the message “**OK**” in case of a positive result of the tests (see Table 3).

STS		15/10 – 18:04	
L1-N = 0 V		CP = 9.1 V	
L1-PE = 3 V		F = 0 Hz	
N-PE = 3 V		I = 0.0 A	
<b>OK</b>			
B			
STATUS			

38. Press the **SAVE** key to partially save the test, and to carry on with the subsequent test (no. 41 to check status C (non-ventilated EVSE system) or no. 47 to check status D (ventilated EVSE system)).

39. The instrument displays the message “**FAIL**” in case of a negative result of at least one test (see Table 3).

STS		15/10 – 18:04	
L1-N = 0 V		CP = 9.1 V	
L1-PE = 15.6 V		F = 0 Hz	
N-PE = 3 V		I = 0.0 A	
<b>FAIL</b>			
B			
STATUS			

40. Press the **SAVE** key to partially save the test and to **end the sequence of tests**. The instrument shows the message contained in the following screen for a few seconds.

Repeat the sequence again, if necessary.

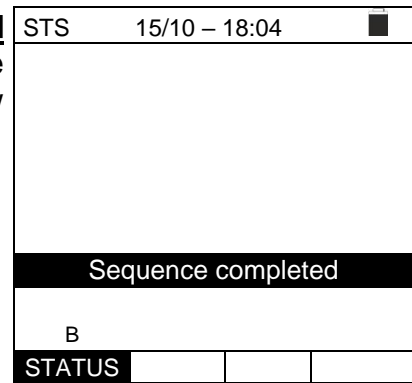

41. **In case of an EVSE system in a non-ventilated environment (Vent = OFF)**, connect the instrument to the adapter as shown in the diagram on the display (input **B4** to input **N**, input **B3** to input **E** and input **B1** to input **L1**). **Use the three selectors of the adapter and set the following positions:**

- PP State → **13A,20A,32A** or **63A**
- CP State → **C**
- Fault → **OK**

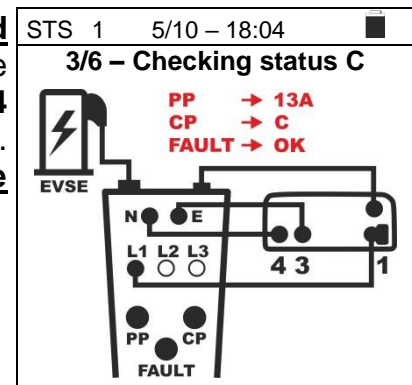

42. Press the **GO/STOP** key. The following screen appears on the display. Notice the presence of the status “**C**” corresponding to the position “STATUS”

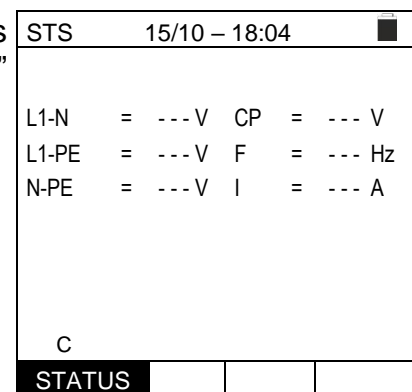

43. Press the **GO/STOP** key. The result of measurements is shown in the screen on the side. The instrument displays the message “**OK**” in case of a positive result of the tests (see Table 3).

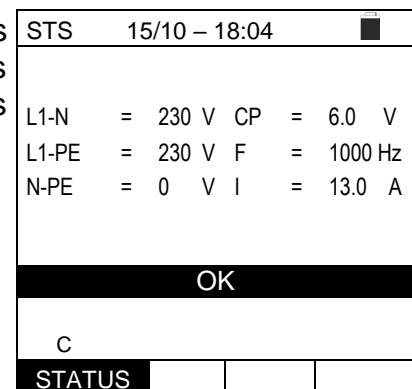

44. Press the **SAVE** key to partially save the test, and to carry on with the subsequent test (no. 53).

45. The instrument displays the message "**FAIL**" in case of a negative result of at least one test (see Table 3)

STS		15/10 – 18:04		■	
L1-N	=	195 V	CP	=	6.0 V
L1-PE	=	230 V	F	=	1000 Hz
N-PE	=	0 V	I	=	13.0 A
<b>NO OK</b>					
C					
<b>STATUS</b>					

46. Press the **SAVE** key to partially save the test and to **end the sequence of tests**. The instrument shows the message contained in the following screen for a few seconds.

Repeat the sequence again, if necessary.

STS		15/10 – 18:04		■	
<b>Sequence completed</b>					
C					
<b>STATUS</b>					

47. **In case of an EVSE system in a non-ventilated environment (Vent = OFF)**, connect the instrument to the adapter as shown in the diagram on the display (input **B4** to input **N**, input **B3** to input **E** and input **B1** to input **L1**). **Use the three selectors of the adapter and set the following positions:**

- PP State → 13A,20A,32A or 63A
- CP State → D
- Fault → OK

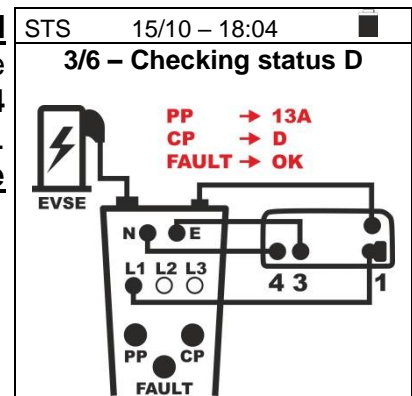

**NOTE: the EVSE station should have the possibility to manually or automatically activate the forced ventilation system.**

48. Press the **GO/STOP** key. The following screen appears on the display. Notice the presence of the status "**D**" corresponding to the position "STATUS"

STS		15/10 – 18:04		■	
L1-N	=	--- V	CP	=	--- V
L1-PE	=	--- V	F	=	--- Hz
N-PE	=	--- V	I	=	--- A
D					
<b>STATUS</b>					

49. Press the **GO/STOP** key. The result of measurements is shown in the screen on the side. The instrument displays the message "**OK**" in case of a positive result of the tests (see Table 3)

STS	15/10 – 18:04		■
L1-N	= 230 V	CP	= 3.0 V
L1-PE	= 230 V	F	= 1000 Hz
N-PE	= 0 V	I	= 13.0 A
<b>OK</b>			
D			
STATUS			

50. Press the **SAVE** key to partially save the test, and to carry on with the subsequent test for the **simulation of a fault on PE** (no. 53).

51. The instrument displays the message "**FAIL**" in case of a negative result of at least one test (see Table 3)

STS	15/10 – 18:04		■
L1-N	= 230 V	CP	= 3.0 V
L1-PE	= 191 V	F	= 1000 Hz
N-PE	= 0 V	I	= 13.0 A
<b>FAIL</b>			
D			
STATUS			

52. Press the **SAVE** key to partially save the test and to **end the sequence of tests**. The instrument shows the message contained in the following screen for a few seconds.

Repeat the sequence again, if necessary.

STS	15/10 – 18:04		■
<b>Sequence completed</b>			
D			
STATUS			

53. Connect the instrument to the adapter as shown in the diagram on the display (input **B4** to input **N**, input **B3** to input **E** and input **B1** to input **L1**). **Use the three selectors of the adapter and set the following positions:**

- PP State → **13A,20A,32A** or **63A**
- CP State → **C**
- Fault → **PE**

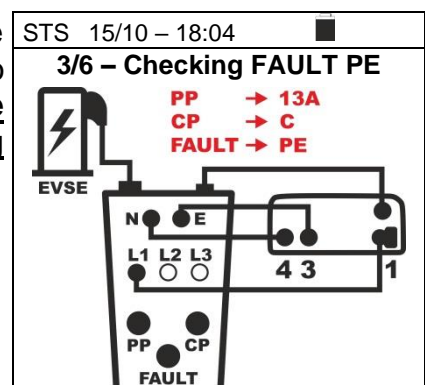

54. Press the **GO/STOP** key to start the test **on PE status**. The following screen appears on the display. Notice the presence of the status "**FAULT PE**" corresponding to the position "STATUS"

STS	15/10 – 18:04		
L1-N	= --- V	CP	= --- V
L1-PE	= --- V	F	= --- Hz
N-PE	= --- V	I	= --- A
FAULT PE			
<b>STATUS</b>			

55. Press the **GO/STOP** key. The result of measurements is shown in the screen on the side. The instrument displays the message "**OK**" in case of a positive result of the tests (see Table 3)

STS	15/10 – 18:04		
L1-N	= 0 V	CP	= 11 V
L1-PE	= 0 V	F	= 0 Hz
N-PE	= 0 V	I	= 0.0 A
<b>OK</b>			
FAULT PE			
<b>STATUS</b>			

56. Press the **SAVE** key to partially save the test, and to carry on with the subsequent test for the **simulation of a fault on E** (no. 59).

57. The instrument displays the message "**FAIL**" in case of a negative result of at least one test (see Table 3)

STS	15/10 – 18:04		
L1-N	= 0 V	CP	= 11 V
L1-PE	= 0 V	F	= 0 Hz
N-PE	= 0 V	I	= 0.0 A
<b>FAIL</b>			
FAULT PE			
<b>STATUS</b>			

58. Press the **SAVE** key to partially save the test and to **end the sequence of tests**. The instrument shows the message contained in the following screen for a few seconds.

Repeat the sequence again, if necessary.

STS	15/10 – 18:04		
<b>Sequence completed</b>			
FAULT PE			
<b>STATUS</b>			

59. Connect the instrument to the adapter as shown in the diagram on the display (input **B4** to input **N**, input **B3** to input **E** and input **B1** to input **L1**). Use the three selectors of the adapter and set the following positions:

- PP State → 13A,20A,32A or 63A
- CP State → C
- Fault → E

**NOTE: some EVSE stations may not be able to manage this fault condition. In this case, leave the Fault selector in position PE to carry out this test.**

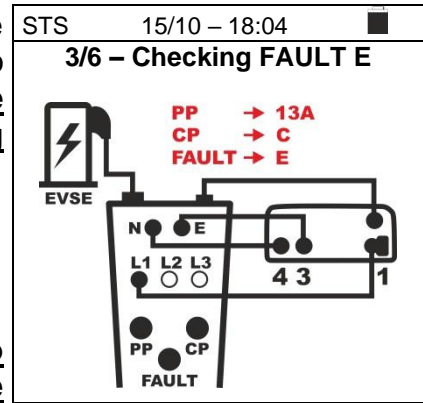

60. Press the **GO/STOP** key to start the test on E status. The following screen appears on the display. Notice the presence of the status "**FAULT E**" corresponding to the position "STATUS".

STS		15/10 – 18:04	
<b>3/6 – Checking FAULT E</b>			
<p>L1-N = --- V CP = --- V                  L1-PE = --- V F = --- Hz                  N-PE = --- V I = --- A</p>			
FAULT E			
STATUS			

61. Press the **GO/STOP** key. The result of measurements is shown in the screen on the side. The instrument displays the message "**OK**" in case of a positive result of the tests (see Table 3)

STS		15/10 – 18:04	
<p>L1-N = 0 V CP = 11 V                  L1-PE = 0 V F = 0 Hz                  N-PE = 0 V I = 0.0 A</p>			
<b>OK</b>			
FAULT E			
STATUS			

62. Press the **SAVE** key to end the test on status check, save the final result in the instrument's memory and go on to the subsequent test (no. 65).

63. The instrument displays the message "**FAIL**" in case of a negative result of at least one test (see Table 3)

STS		15/10 – 18:04	
<p>L1-N = 19.6 V CP = 11 V                  L1-PE = 4 V F = 0 Hz                  N-PE = 0 V I = 0.0 A</p>			
<b>FAIL</b>			
FAULT E			
STATUS			

64. Press the **SAVE** key to partially save the test and to **end the sequence of tests**. The instrument shows the message contained in the following screen for a few seconds.

Repeat the sequence again, if necessary.

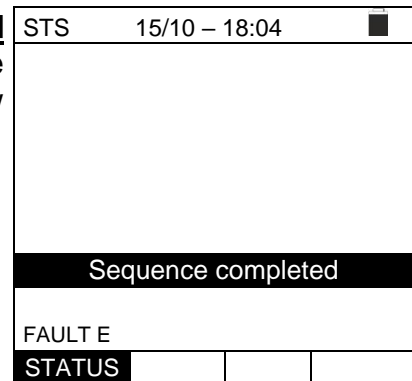

Test 4 → Measurement of overall earth resistance of the EVSE system

TT system

65. Connect the instrument to the adapter as shown in the diagram on the display (input **B4** to input **N (L2 in split-phase systems)**), input **B3** to input **E** and input **B1** to input **L1**). **Use the three selectors of the adapter and set the following positions:**

- PP State → 13A,20A,32A or 63A
- CP State → C
- Fault → OK

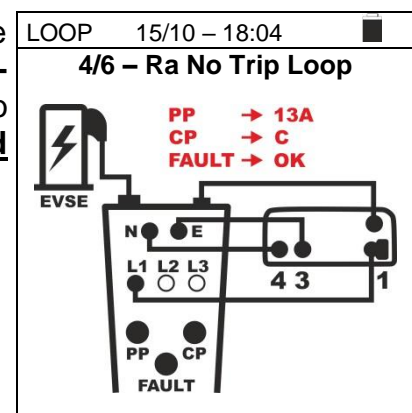

66. This test is carried out by the instrument **only in "3-wire Ra NoTrip mode"**. Please refer to § 6.7.9 for a description of the setting of the test parameters as regards the RCD's tripping current of the EVSE system and to § 6.7.2 for a preliminary calibration of the test leads.

Notice the presence of the correct voltage values between L-PE and L-N as shown in the screen on the side.

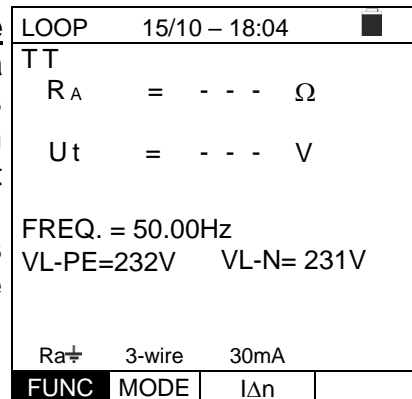

67. Press the **GO/STOP** key. The instrument will start measuring and the display will show the message **"Measuring..."**. During this whole stage, do not disconnect the test leads of the instrument from the system being tested. The following screen appears on the display.

In case of a **positive result (overall earth resistance R<sub>a</sub> < (U<sub>lim</sub> / IΔn)**, the instrument displays the message **"OK"** and the screen on the side, which contains the value of contact voltage on the secondary display.

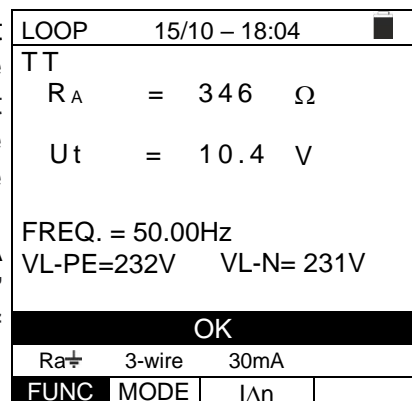

68. Press the **SAVE** key to partially save the test, and to carry on with the subsequent test (no. 76).

69. In case of a **negative** result (**overall earth resistance  $R_A > (U_{lim} / I_{\Delta n})$** ), the instrument displays the message "**NO OK**" and the screen on the side, which contains the value of contact voltage on the secondary display.

LOOP	15/10 – 18:04	■	
TT			
$R_A$	=	1765	$\Omega$
$U_t$	=	>50	V
FREQ. = 50.00Hz			
VL-PE=232V		VL-N= 231V	
<b>NO OK</b>			
$R_A$	3-wire	30mA	
<b>FUNC</b>	<b>MODE</b>	$I_{\Delta n}$	

70. Press the **SAVE** key to partially save the test and to **end the sequence of tests**. The instrument shows the message contained in the following screen for a few seconds.

Repeat the sequence again, if necessary.

LOOP	15/10 – 18:04	■	
Sequence completed			
$R_A$	3-wire	30mA	
<b>FUNC</b>	<b>MODE</b>	$I_{\Delta n}$	

### TN system

71. This test is carried out by the instrument **only in "3-wire  $R_A$  NoTrip mode" with fixed RCD protection**. Please refer to § 6.7.7 for a description of the setting of the test parameters as regards the RCD's tripping current of the EVSE system and to § 6.7.2 for a preliminary calibration of the test leads.

Notice the presence of the correct voltage values between L-PE and L-N as shown in the screen on the side.

LOOP	15/10 – 18:04	■	
TN			
$I_{sc}$	=---	A	$Z_{L-N}$ = --- $\Omega$
$I_{fc}$	=---	A	$Z_{L-PE}$ = --- $\Omega$
FREQ = 50.00Hz			
VL-PE = 232V		VL-N = 231V	
$R_A$	3-wire	30mA	
<b>FUNC</b>	<b>MODE</b>	$I_{\Delta n}$	

72. Press the **GO/STOP** key. The instrument will start measuring and the display will show the message "**Measuring...**".

During this whole stage, do not disconnect the test leads of the instrument from the system being tested.

In case of a **positive** result ( **$Z_{L-PE} < U_{lim}/I_{\Delta n}$** ), the instrument shows the message "**OK**" and the screen on the side.

LOOP	15/10 – 18:04	■	
TN			
$I_{sc}$	= 1365A	$Z_{L-N}$	= 0.16 $\Omega$
$I_{fc}$	= 1213A	$Z_{L-PE}$	= 0.18 $\Omega$
FREQ = 50.00Hz			
VL-N = 232V		VL-PE = 231V	
<b>OK</b>			
$R_A$	3-wire	30mA	
<b>FUNC</b>	<b>MODE</b>	$I_{\Delta n}$	

73. Press the **SAVE** key to partially save the test, and to carry on with the subsequent test (no. 76).

74. In case of a **negative** result ( $ZL-PE > Utlim/I\Delta n$ ), the instrument shows the message "FAIL" and the screen on the side.

LOOP 15/10 – 18:04			
TN			
Isc=0.13A	ZL-N=1730Ω		
Ifc=0.13A	ZL-PE=1734Ω		
FREQ=50.00Hz			
VL-N=232V		VL-PE=231V	
<b>FAIL</b>			
Ra	3-wire	30mA	
<b>FUNC</b>	MODE	IΔn	

75. Press the **SAVE** key to partially save the test and to **end the sequence of tests**. The instrument shows the message contained in the following screen for a few seconds.

Repeat the sequence again, if necessary.

LOOP 15/10 – 18:04			
Sequence completed			
Ra	3-wire	30mA	
<b>FUNC</b>	MODE	IΔn	

Test 5 → Test of RCD Type A/F or CCID (USA country) of the EVSE system

76. Connect the instrument to the adapter as shown in the diagram on the display input **B4** to input **N** (**L2 in split-phase systems**), input **B3** to input **E** and input **B1** to input **L1**. **Use the three selectors of the adapter and set the following positions:**

- PP State → 13A, 20A, 32A or 63A
- CP State → C
- Fault → OK

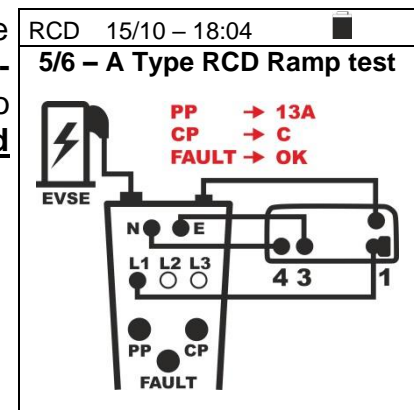

77. This test is carried out by the instrument by **only considering standard STD (G) RCDs, of type A/F and in Ramp mode (0°), no display of contact voltage Ut, rated current selectable among the following values: 6,10,30,100,300,500,650mA or type CCID rated current selectable between 5,20mA**. Please refer to § 6.6.4 for a description of the setting of the test parameters.

Notice the presence of the correct voltage values between L-PE and L-N as shown in the screen on the side.

RCD 15/10 – 18:04			
TT			
I =	- - - mA		
T =	- - - ms	Ut =	- - - V
FREQ. = 50.00Hz			
VL-PE=231V		VL-N=234V	
	30mA	0°	No Ut
<b>MODE</b>	IΔn	Type	Ut

78. Press the **GO/STOP** key. The instrument will start measuring and the display will show the message “**Measuring...**”. During this whole stage, do not disconnect the test leads of the instrument from the system being tested. The following screen appears on the display:

RCD 15/10 – 18:04			
TT			
I =		24 mA	
T =		26 ms Ut= --- V	
FREQ. = 50.00Hz			
VL-PE=231V		VL-N=234V	
<b>OK</b>			
30mA   No Ut			
<b>MODE</b>	IΔn	Type	Ut

When the RCD trips and breaks the circuit, in case the tripping time and the tripping current are within the limits reported in § 12.4, the instrument gives out a double acoustic signal which indicates the display of the message “**OK**” and of the screen to the side.

79. Press the **SAVE** key to partially save the test, and to carry on with the subsequent test (no. 83).

80. Activate the EVSE system again in the following way:

- Move selector CP State → **A**
- Move selector CP State → **C**
- If the RCD trips, reset it.

RCD 15/10 – 18:04			
RCD tripping Ok.			
To restore the EVSE system, turn CP to A and go back to the current position. If the external RCD trips, reset it.			

81. At the end of the test, if the tripping current is not within the values indicated in § 10.1, the instrument displays the message “**FAIL**” to indicate the negative outcome of the test and displays a screen like the one on the side.

RCD 15/10 – 18:04			
TT			
I =		>33 mA	
T >		300 ms U= --- V	
FREQ. = 50.00Hz			
VL-PE=231V		VL-N=234V	
<b>FAIL</b>			
30mA   No Ut			
<b>MODE</b>	IΔn	Type	Ut

82. Press the **SAVE** key to partially save the test and to **end the sequence of tests**. The instrument shows the message contained in the following screen for a few seconds.

Repeat the sequence again, if necessary.

RCD 15/10 – 18:04			
<b>Sequence completed</b>			
30mA   No Ut			
<b>MODE</b>	IΔn	Type	Ut

Test 6 → Test of RCD Type B/B+ or **CCID** (USA country) of the EVSE system

83. Connect the instrument to the adapter as shown in the diagram on the display input **B4** to input **N** (**L2 in split-phase systems**), input **B3** to input **E** and input **B1** to input **L1**. **Use the three selectors of the adapter and set the following positions:**

- PP State → 13A,20A,32A or 63A
- CP State → C
- Fault → OK

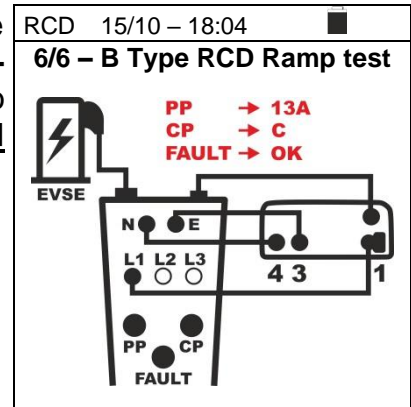

84. This test is carried out by the instrument by **only considering standard STD (G) RCDs, of type B/B+ and in Ramp mode (▲) 0° (==/==+), no display of contact voltage  $U_t$ , rated current selectable among the following values: 6,10,30,100,300,500,650mA or type CCID (==↑) rated current selectable between 5,20mA**. Please refer to § 6.6.4 for a description of the setting of the test parameters.

Notice the presence of the correct voltage values between L-PE and L-N as shown in the screen on the side.

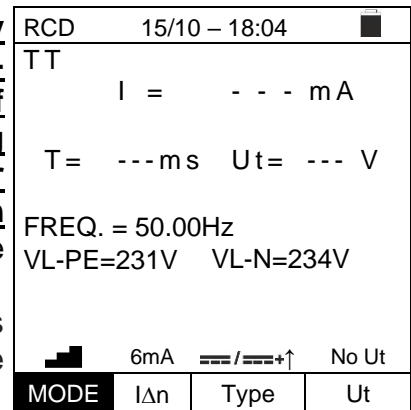

85. Press the **GO/STOP** key. The instrument will start measuring and the display will show the message **“Measuring...”**. During this whole stage, do not disconnect the test leads of the instrument from the system being tested. The following screen appears on the display:

When the RCD trips and breaks the circuit, in case the tripping time and the tripping current are within the limits reported in § 12.4, the instrument gives out a double acoustic signal which indicates the display of the message **“OK”** and of the screen to the side.

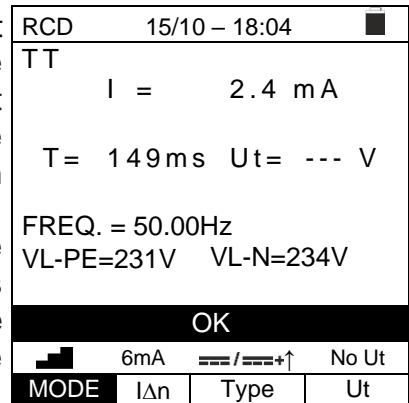

86. At the end of the test, if the tripping current is not within the values indicated in § 10.1, the instrument displays the message **“FAIL”** to indicate the negative outcome of the test and displays a screen like the one on the side.

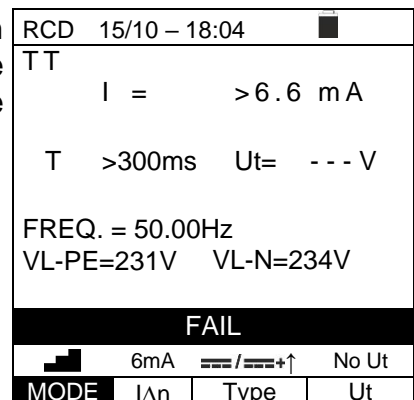

87. Press the **SAVE** key to partially save the test and to **end the sequence of tests.** In case of a positive result, the instrument shows the message contained in the following screen for a few seconds.

88. Repeat the sequence again, if necessary.

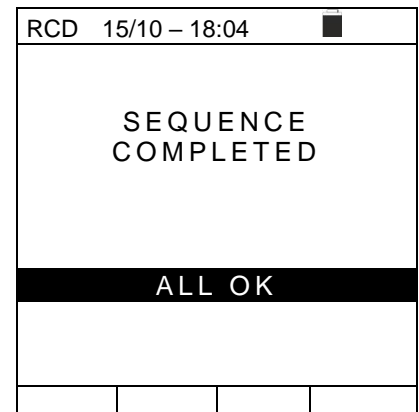

## 7. STORING RESULTS

The instrument allows saving max 999 measured values. The saved data can be recalled to the display and deleted at any moment, and, upon saving, they can be associated with up to a maximum of 3 levels of numeric markers relevant to the installation name, the PV string and the PV module (with max value 250). For each level, 20 marker names are available, which can be customized by the user, if needed, **through PC connection with the provided management software**. It is also possible to add a comment associated with each measure.

### 7.1. SAVING MEASURES

4. Press the **SAVE/ENTER** key with the measured result on the display. The screen to the side appears on the display. It contains:

- Item “Measurement” which identifies the first available memory location
- The first marker (e.g.: “Installation”) to which a numeric value between 1 ÷ 250 can be associated
- The second marker (e.g.: “String”) to which a numeric value between 0 (- - -) ÷ 250 can be associated
- The third marker (e.g.: “Module”) to which a numeric value between 0 (- - -) ÷ 250 can be associated
- Item “Comment” associated with the measure, in which a text of **max 30 digits** can be entered

SAVE	15/10 – 18:04	■
Measure	003	
Installation	<b>001</b>	
String	---	
Module	---	
Comment:	max 30 digits	

5. Use the arrow keys ◀ or ▶ to select the marker and the arrow keys (▲, ▼) to change the label of the associated numeric value (e.g.: “Area”) among those available or customizable by the user (max 20 names).

6. Select item “Comment” and press the **SAVE/ENTER** key to enter the desired text. The following screen with virtual keyboard appears on the display:

SAVE	15/10 – 18:04	■
Measure	003	
<b>Area</b>	001	
String	---	
Module	---	
<b>Comment:</b>	max 30 digits	

7. Use the arrow keys ◀ or ▶ to move the cursor to the selected digit and press the **SAVE/ENTER** key to enter comment.

8. Move the cursor to “DEL” and press the **SAVE/ENTER** key to delete the selected digit.

9. Move the cursor to “END” and press the **SAVE/ENTER** key to confirm the written comment and go back to the previous screen.

SAVE	15/10 – 18:04	■
Keyboard		
COMMENT		
0 1 2 3 4 5 6 7 8 9 0 ( ) %		
Q W E R T Y U I <b>█</b> P <=> #		
A S D F G H J K L + - * / &		
Z X C V B N M . , ; : ! ? _		
Ä Ö Ü ß µ Ñ Ç Á Í Ó Ú Û Ü ÿ		
À È É Ù Ç Ä Æ Ĩ Ö Û Æ Ø Å		
CANC		<b>END</b>

10. Press the **SAVE/ENTER** key to confirm saving the measure or **ESC/MENU** to exit without saving.

## 7.2. RECALL OF DATA TO DISPLAY AND MEMORY DELETION

- Position the cursor onto **MEM** by using the arrow keys (**▲**, **▼**) and confirm with **ENTER**. The screen to the side appears on the display. The screen contains:
  - The number of the memory location where the measure is saved
  - The date in which the measure was saved
  - The type of measure saved
  - The total number of saved measures for each screen and the residual available memory

MEM 15/10 – 18:04		
N.	Date	Type
001	14/01/21	RPE
002	15/01/21	MΩ
003	15/01/21	LoΩ
004	15/01/21	LoZ
005	16/01/21	Auto
006	17/01/21	Loop
007	19/01/21	ΔV%
008	25/05/21	EVSE
Tot: 007		Free: 992
↑↓	↑↓	All
Rec	Pag	DEL

- Use the arrow keys (**▲**, **▼**) to select the measure to be recalled to display.
- Press the **SAVE/ENTER** key to display the saved measure. Press the **ESC/MENU** key to go back to the previous screen.
- Use the arrow keys **◀** or **▶** to select option “Pag” and proceed to the next screen.
- Select the option “DEL” to delete the whole content of the instrument’s memory (“All” option) or the last saved data (“Last” option). The following screen appears on the display

MEM 15/02 – 18:04		
N.	Date	Type
001	14/01/21	RPE
002	15/01/21	MΩ
003	15/01/21	LoΩ
004	15/01/21	LoZ
005	16/01/21	Auto
006	17/01/21	Loop
007	19/01/21	ΔV%
008	25/05/21	EVSE
Tot: 007		Free: 992
↑↓	↑↓	All
Rec	Pag	DEL

- The screen on the side reports a display recall of measurements carried out on an EVSE test with positive result

MEM 15/02 – 18:04	
RPE	OK
MΩ	OK
STATUS	OK
Ra	OK
RCD A	OK
RCD B	OK
OK	

- Press the **SAVE/ENTER** key to confirm data deletion. The message “**Memory empty**” is shown on the display.
- Press the **MENU/ESC** key to exit the function and go back to the general menu.

MEM 15/10 – 18:04	
DELETE ALL?	
ENTER / ESC	

## 8. CONNECTING THE INSTRUMENT TO THE PC

The connection between a PC and the instrument can be done via a serial port (see Fig. 1 – part 4) by means of an optical cable/USB C2006 or by means a WiFi connection. The choice of the type of connection must be made within the management software (see the help on line of the program)

### CAUTION



- In order to transfer the data onto a PC by means of an optical cable/USB C2006 it is necessary to install beforehand both the management software on the PC itself.
- Before connecting, it is necessary to select the port to be used and the correct baud rate (57600 bps) on the PC. To set these parameters, launch the provided management software and refer to the program's on-line help.
- The selected port must not be engaged by other devices or applications, e.g. a mouse, a modem, etc. Close any applications running using the Microsoft Windows Task Manager function, if necessary.
- The optical port emits invisible LED radiations. Do not directly observe with optical instruments. Class 1M LED apparatus according to standard IEC/EN 60825-1.

To transfer data to the PC, follow this procedure:

1. Switch on the instrument by pressing the **ON/OFF** key.
2. Connect the instrument to the PC via the provided optical/USB cable **C2006**.
3. Press the **ESC/MENU** key to open the main menu.
4. Use the arrow keys (**▲**, **▼**) to select "**PC**", to access data transfer mode and confirm with **SAVE/ENTER**.

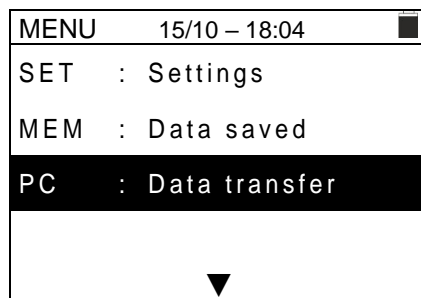

5. The internal WiFi module is automatically activated and provides the followed screen:

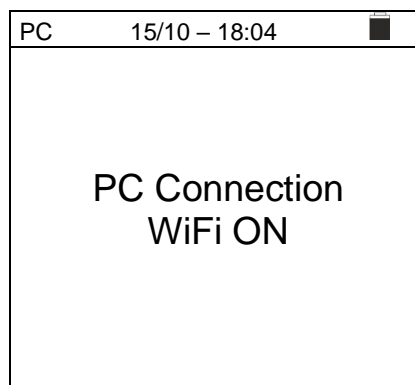

6. Use the software controls to activate data transfer (please refer to the on-line help of the program).

## 9. MAINTENANCE

### 9.1. GENERAL INFORMATION

- While using and storing the instrument, carefully observe the recommendations listed in this manual in order to prevent possible damage or danger during use.
- Do not use the instrument in environments with high humidity levels or high temperatures. Do not expose to direct sunlight.
- Always switch off the instrument after use. Should the instrument remain unused for a long time, remove the batteries to avoid liquid leaks that could damage the instrument's internal circuits.

### 9.2. REPLACEMENT OF THE BATTERIES

When the LCD display shows the low battery symbol , replace the alkaline batteries.



#### CAUTION

Only expert and trained technicians should perform this operation. Before carrying out this operation, make sure you have disconnected all cables from the input terminals.

1. Switch off the instrument by pressing the **ON/OFF** key.
2. Remove the cables from the inputs
3. Loosen the battery compartment cover fastening screw and remove the cover.
4. Remove all the batteries from the battery compartment and replace them with new batteries of the right type only (see § 10.2), making sure to respect the indicated polarities.
5. Restore the battery compartment cover into place and fasten it by means of the relevant screw.
6. Do not scatter old batteries into the environment. Use the relevant containers for disposal.

### 9.3. CLEANING THE INSTRUMENT

Use a soft and dry cloth to clean the instrument. Never use wet cloths, solvents, water, etc.

### 9.4. END OF LIFE



**CAUTION:** the symbol on the instrument indicates that the appliance and its accessories must be collected separately and correctly disposed of.

## 10. TECHNICAL SPECIFICATIONS

Accuracy is calculated as:  $\pm[\% \text{reading} + (\text{no. of digits}) * \text{resolution}]$  at 23°C, <80%RH

### 10.1. TECHNICAL CHARACTERISTICS

#### AC TRMS voltage

Range [V]	Resolution [V]	Accuracy
15 ÷ 460	1	$\pm(3\% \text{rdg} + 2 \text{dgt})$

#### Frequency

Range [Hz]	Resolution [Hz]	Accuracy
47.50 ÷ 52.50 / 57.00 ÷ 63.00	0.01	$\pm(0.1\% \text{rdg} + 1 \text{dgt})$

#### Continuity of protective conductor (RPE)

Range [ $\Omega$ ]	Resolution [ $\Omega$ ]	Accuracy
0.00 ÷ 9.99	0.01	$\pm(5.0\% \text{rdg} + 3 \text{dgt})$
10.0 ÷ 99.9	0.1	
100 ÷ 1999	1	

Test current: >200mA DC up to 5 $\Omega$  (test leads included)

Test current generated: 1mA resolution, range 0 ÷ 250mA

Open-circuit voltage:  $4 < V_0 < 24 \text{VDC}$

Safety protection: error message for input voltage >10V

#### Insulation resistance (M $\Omega$ )

Test voltage [V]	Range [M $\Omega$ ]	Resolution [M $\Omega$ ]	Accuracy
50	0.01 ÷ 9.99	0.01	$\pm(2.0\% \text{rdg} + 2 \text{dgt})$
	10.0 ÷ 49.9	0.1	$\pm(5.0\% \text{rdg} + 2 \text{dgt})$
	50.0 ÷ 99.9		
100	0.01 ÷ 9.99	0.01	$\pm(2.0\% \text{rdg} + 2 \text{dgt})$
	10.0 ÷ 99.9	0.1	$\pm(5.0\% \text{rdg} + 2 \text{dgt})$
	100 ÷ 199	1	
250	0.01 ÷ 9.99	0.01	$\pm(2.0\% \text{rdg} + 2 \text{dgt})$
	10.0 ÷ 199.9	0.1	$\pm(5.0\% \text{rdg} + 2 \text{dgt})$
	200 ÷ 249	1	
250 ÷ 499			
500	0.01 ÷ 9.99	0.01	$\pm(2.0\% \text{rdg} + 2 \text{dgt})$
	10.0 ÷ 199.9	0.1	$\pm(5.0\% \text{rdg} + 2 \text{dgt})$
	200 ÷ 499	1	
500 ÷ 999			
1000	0.01 ÷ 9.99	0.01	$\pm(2.0\% \text{rdg} + 2 \text{dgt})$
	10.0 ÷ 199.9	0.1	$\pm(5.0\% \text{rdg} + 2 \text{dgt})$
	200 ÷ 1999	1	

Open-circuit voltage: rated test voltage -0% +10%

Rated measuring current: >1mA with 1k $\Omega$  x Vnom (50V, 100V, 250V, 1000V), >2.2mA with 230k $\Omega$  @ 500V

Short-circuit current: <6.0mA for each test voltage

Safety protection: error message for input voltage >30V

#### Line/Loop impedance (Phase-Phase, Phase-Neutral, Phase-Earth)

Range [ $\Omega$ ]	Resolution [ $\Omega$ ]	Accuracy (*)
0.01 ÷ 9.99	0.01	$\pm(5\% \text{rdg} + 3 \text{dgt})$
10.0 ÷ 199.9	0.1	

(\*) 0.1m $\Omega$  in range 0.1 ÷ 199.9 m $\Omega$  (by using the optional accessory IMP57)

Maximum test current: 3.31A (at 265V); 5.71A (at 457V)

P-N/P-P Test voltage: (100V  $\pm$ 265V) / (100V $\div$ 460V); 50/60Hz  $\pm$ 5%

Protection types: MCB (B, C, D, K), Fuse (aM, gG, BS882-2, BS88-3, BS3036, BS1362)

#### First fault current – IT systems

Range [mA]	Resolution [mA]	Accuracy
0.1 ÷ 0.9	0.1	$\pm(5\% \text{rdg} + 1 \text{dgt})$
1 ÷ 999	1	$\pm(5\% \text{rdg} + 3 \text{dgt})$

Limit contact voltage (ULIM) : 25V, 50V

**Test on RCD protection (molded-case type)**

Differential protection type (RCD): AC(⌚), A/F(⌚), B/B+(⌚), CCID (⌚ - USA country), General (G), Selective (S)

**Single -phase systems (L-N-PE)**

 Voltage range L-PE, L-N: 100V ÷265V RCD type AC, A/F, B/B+ and CCID ( $I_{\Delta N} \leq 100\text{mA}$ )  
 190V ÷265V RCD type B/B+ ( $I_{\Delta N} = 300\text{mA}$ )  
 <10V

Voltage range N-PE:

**Split-phase systems (phase delay VL1-PE, VL2-PE = 180° or phase delay VL1-PE, VL2-PE = 120°)**

 Voltage range L1-PE, L1-L2: 100V ÷265V RCD type AC, A/F, B/B+ and CCID ( $I_{\Delta N} \leq 100\text{mA}$ )

 Voltage range L2-PE: 0V ÷265V RCD type AC, A/F  
 0V ÷ min[(VL1-PE-100V) and (VL1-L2-100V)], RCD type B/B+ ( $I_{\Delta N} \leq 100\text{mA}$ )

 Rated tripping currents ( $I_{\Delta N}$ ): 5mA, 6mA, 10mA, 20mA, 30mA, 100mA, 300mA, 500mA, 650mA, 1000mA

Frequency: 50/60Hz ± 5%

**Molded-case RCD tripping current - (for General RCDs only)**

RCD type	$I_{\Delta N}$	Range $I_{\Delta N}$ [mA]	Resolution [mA]	Accuracy
CCID	5mA, 20mA	$(0.2 \div 1.3) I_{\Delta N}$	$\leq 0.1 I_{\Delta N}$	- 0%, +10% $I_{\Delta N}$
AC, A/F, B/B+	6mA, 10mA	$(0.2 \div 1.1) I_{\Delta N}$		- 0%, +5% $I_{\Delta N}$
AC, A/F, B/B+	$30\text{mA} \leq I_{\Delta N} \leq 300\text{mA}$			
AC, A/F	$500\text{mA} \leq I_{\Delta N} \leq 650\text{mA}$			

**Measurement duration of molded-case RCD tripping time – TT/TN systems**

	x 1/2		x 1		x 5		AUTO				AUTO+	
	\	G	S	G	S	G	S	G	S	G	S	
5mA	AC											
	A/F											
	B/B+											
	CCID			999						310		
6mA	AC	999	999	999	999	50	150	✓	✓	310		✓
	A/F	999	999	999	999	50	150	✓	✓	310		✓
	B/B+	999	999	999	999					310		
	CCID											
10mA	AC	999	999	999	999	50	150	✓	✓	310		✓
	A/F	999	999	999	999	50	150	✓	✓	310		✓
	B/B+	999	999	999	999					310		
	CCID											
20mA	AC											
	A/F											
	B/B+											
	CCID			999						310		
30mA	AC	999	999	999	999	50	150	✓	✓	310		✓
	A/F	999	999	999	999	50	150	✓	✓	310		✓
	B/B+	999	999	999	999					310		
	CCID											
100mA	AC	999	999	999	999	50	150	✓	✓	310		
	A/F	999	999	999	999	50	150	✓	✓	310		
	B/B+	999	999	999	999					310		
	CCID											
300mA	AC	999	999	999	999	50	150	✓	✓	310		
	A/F	999	999	999	999	50	150	✓	✓	310		
	B/B+	999	999	999	999					310		
	CCID											
500mA 650mA	AC	999	999	999	999	50	150	✓	✓	310		
	A/F	999	999	999	999					310		
	B/B+											
	CCID											
1000mA	AC	999	999	999								
	A/F	999	999	999								
	B/B+											
	CCID											

Table with duration of tripping time measurement [ms] - Resolution: 1ms, Accuracy: ±(2.0% reading + 2digits)

**NOTE: RCD type CCID available only for USA country and TN systems**

**Measurement duration of molded-case RCD tripping time – IT systems**

	x 1/2		x 1		x 5		AUTO				AUTO+	
	\	G	S	G	S	G	S	G	S	G	S	
<b>6mA</b>	AC	999	999	999	999	999	50	150	✓	✓	310	✓
<b>10mA</b>	A/F	999	999	999	999	999	50	150	✓	✓	310	✓
<b>30mA</b>	B/B+	999	999	999	999	999					310	
<b>100mA</b>	AC	999	999	999	999	999	50	150	✓	✓	310	
<b>300mA</b>	A/F	999	999	999	999	999	50	150	✓	✓	310	
	B/B+	999	999	999	999	999					310	
<b>500mA</b>	AC	999	999	999	999	999	50	150	✓		310	
<b>650mA</b>	A/F	999	999	999	999	999			✓		310	
	B/B+											
<b>1000mA</b>	AC	999	999	999	999	999						
	A/F	999	999	999	999	999						
	B/B+											

 Table with duration of tripping time measurement [ms] - Resolution: 1ms, Accuracy:  $\pm(2.0\% \text{reading} + 2 \text{digits})$ 
**Test on RCD protection (DD type)**

Differential protection type (RCD):

DD type (compliance with IEC62955 guideline), General (G)

**Single -phase systems (L-N-PE)**

Voltage range L-PE, L-N:

 $100V \pm 265V$ 

Voltage range N-PE:

 $<10V$ 
**Split-phase systems (phase delay VL1-PE, VL2-PE = 180° or phase delay VL1-PE, VL2-PE = 120°)**

Voltage range L1-PE, L1-L2:

 $100V \pm 265V$ 

Voltage range L2-PE:

 $0V = \min[(VL1-PE-100V) \text{ and } (VL1-L2-100V)]$ 

 Rated tripping currents ( $I_{\Delta N}$ ):

6mA

Frequency:

 $50/60Hz \pm 5\%$ 
**DD type RCD tripping current - (for General RCD only)**

RCD type	$I_{\Delta N}$	Range [mA]	Resolution [mA]	Accuracy
DD	6mA	$(0.2 \div 1.1) I_{\Delta N}$	$\leq 0.1 I_{\Delta N}$	- 0%, +10% $I_{\Delta N}$

**DD type RCD tripping time x1 - (for General RCD only)**

RCD type	$I_{\Delta N}$	Range [ms]	Resolution [ms]	Accuracy
DD	6mA	10000	1	$\pm(2\% \text{rdg} + 2 \text{digits})$

**Overall earth resistance without RCD tripping ( $R_{a\frac{1}{2}}$ )**

Voltage range P-PE, P-N:

 $100V \pm 265V$ 

Voltage range N-PE:

 $<10V$ 

Frequency:

 $50/60Hz \pm 5\%$ 
**Overall earth resistance in systems with Neutral (3-wire) – (30mA or higher RCD)**

Range [ $\Omega$ ]	Resolution [ $\Omega$ ]	Accuracy
0.05 $\div$ 9.99	0.01	$\pm(5\% \text{rdg} + 8 \text{dgt})$
10.0 $\div$ 199.9	0.1	

**Overall earth resistance in systems with Neutral (3-wire) – (6mA and 10mA RCD)**

Range [ $\Omega$ ]	Resolution [ $\Omega$ ]	Accuracy
0.05 $\div$ 9.99	0.01	$\pm(5\% \text{rdg} + 30 \text{dgt})$
10.0 $\div$ 199.9	0.1	

**Overall earth resistance in systems without Neutral (2-wire) – (30mA or higher RCD)**

Range [ $\Omega$ ]	Resolution [ $\Omega$ ]	Accuracy
0.05 $\div$ 9.99	0.01	$\pm(5\% \text{rdg} + 8 \text{dgt})$
10.0 $\div$ 99.9	0.1	
100 $\div$ 1999	1	

**Overall earth resistance in systems without Neutral (2-wire) – (6mA and 10mA RCD)**

Range [ $\Omega$ ]	Resolution [ $\Omega$ ]	Accuracy
0.05 ÷ 9.99	0.01	±(5%rdg + 30dgt)
10.0 ÷ 99.9	0.1	
100 ÷ 1999	1	

**Contact voltage (measured during RCD and  $R_{a-f}$  test)**

Range [V]	Resolution [V]	Accuracy
0 ÷ $U_t$ LIM	0.1	-0%, +(5.0% rdg + 3V)

**Phase rotation with 1 test lead**

Voltage range P-N, P-PE[V]	Frequency range
100 ÷ 265	50Hz/60Hz ± 5%

Measurement is only carried out by direct contact with metal live parts (not on insulation sheath).

**Voltage drop**

Range [%]	Resolution [%]	Accuracy
0 ÷ 100	0.1	±(10%rdg + 4dgt)

**Environmental parameters (AUX)**

Measurement	Range	Resolution	Accuracy
°C	-20.0 ÷ 60.0°C	0.1°C	±(2%rdg + 2dgt)
°F	-4.0 ÷ 140.0°F	0.1°F	
RH%	0.0% ÷ 100.0%RH	0.1%RH	
DC voltage	-1999.9mV ÷ -1.0mV	0.1mV	
	1.0mV ÷ 1999.9mV		
Lux	0.01 ÷ 20.00lux	0.01Lux	
	1 ÷ 2klux	1Lux	
	1.00 ÷ 20.00klux	0.01kLux	

Values lower to ±1mVDC are zeroed; Values lower to 0.1mVAC are zeroed

**DC Current with transducer clamp (In1 input – STD clamp)**

Range [mV]	Resolution [mV]	Accuracy
-1999.9 ÷ -1.0	0.1	±(5.0%rdg + 2dgt)
1.0 ÷ 1999.9		

Values lower to ±1mVDC are zeroed

**AC TRMS Current with transducer clamp (In1 input – STD clamp)**

Range [mV]	Frequency [Hz]	Resolution [mV]	Accuracy
1.0 ÷ 2999.9	50/60Hz ±5%	0.1	±(5.0%rdg + 2dgt)

Values lower to 1mVAC are zeroed ; Max crest factor: 3

**DC/AC TRMS current with transducer clamp (In1 input – STD clamp)**

FS clamp / Output ratio	Measurement range	Resolution
1A/1V AC	0.1mA ÷ 999.9mA AC	0.1mA AC
5A/1V AC	0.001A ÷ 4.999A AC	0.001A AC
10A/1V AC/DC	0.001A ÷ 9.999A AC/DC	0.001A AC/DC
30A/3V AC	0.01A ÷ 29.99A AC	0.01A AC
40A/400mV AC/DC	0.01A ÷ 39.99A AC/DC	0.01A AC/DC
100A/1V AC/DC	0.01A ÷ 99.99A AC/DC	0.01A AC/DC
200A/1V AC	0.01A ÷ 199.99A AC	0.01A AC
300A/3V AC	0.01A ÷ 299.99A AC	0.01A AC
400A/400mV AC/DC	0.1A ÷ 399.9A AC/DC	0.1A AC/DC
1000A/1V AC/DC	0.1A ÷ 999.9A AC/DC	0.1A AC/DC
2000A/1V AC	0.1A ÷ 1999.9A AC	0.1A AC
3000A/3V AC	0.1A ÷ 2999.9A AC	0.1A AC

## MEASUREMENT OF NETWORK PARAMETERS AND HARMONICS

### DC Voltage

Range [V]	Resolution [V]	Accuracy
15.0 ÷ 265.0	0.1V	±(1.0%rdg + 1dgt)

Values lower 15V are zeroed

### AC TRMS Voltage

Range [V]	Frequency [Hz]	Resolution [V]	Accuracy
15.0 ÷ 459.9	50/60Hz ±5%	0.1V	±(1.0%rdg + 1dgt)

Values lower 15V are zeroed; Max crest factor: 1.5

### Frequency

Range [Hz]	Resolution [Hz]	Accuracy
47.5 ÷ 63.0	0.01	±(2.0%rdg + 2dgt)

Allowed voltage range: 5.0 ÷ 459.9V ; Allowed current range: ≥5mVAC

### DC Current with transducer clamp (In1 input – STD clamp)

Range [mV]	Resolution [mV]	Accuracy
-1999.9 ÷ -1.0	0.1	±(5.0%rdg + 2dgt)
1.0 ÷ 1999.9		

Values lower to ±1mVDC are zeroed

### AC TRMS Current with transducer clamp (In1 input – STD clamp)

Range [mV]	Frequency [Hz]	Resolution [mV]	Accuracy
1.0 ÷ 2999.9	50/60Hz ±5%	0.1	±(5.0%rdg + 2dgt)

Values lower to 1mVAC are zeroed ; Max crest factor: 3

### DC/AC TRMS current with transducer clamp (In1 input – STD clamp)

FS clamp / Output ratio	Measurement range	Resolution
1A/1V AC	0.1mA ÷ 999.9mA AC	0.1mA AC
5A/1V AC	0.001A ÷ 4.999A AC	0.001A AC
10A/1V AC/DC	0.001A ÷ 9.999A AC/DC	0.001A AC/DC
30A/3V AC	0.01A ÷ 29.99A AC	0.01A AC
40A/400mV AC/DC	0.01A ÷ 39.99A AC/DC	0.01A AC/DC
100A/1V AC/DC	0.01A ÷ 99.99A AC/DC	0.01A AC/DC
200A/1V AC	0.01A ÷ 199.99A AC	0.01A AC
300A/3V AC	0.01A ÷ 299.99A AC	0.01A AC
400A/400mV AC/DC	0.1A ÷ 399.9A AC/DC	0.1A AC/DC
1000A/1V AC/DC	0.1A ÷ 999.9A AC/DC	0.1A AC/DC
2000A/1V AC	0.1A ÷ 1999.9A AC	0.1A AC
3000A/3V AC	0.1A ÷ 2999.9A AC	0.1A AC

### DC Power

FS clamp	Range [W]	Resolution [kW]	Accuracy
≤ 10A	0.015 ÷ 2.650k	0.001	±(2.0%rdg + 5 dgt)
10A ≤ FS ≤ 40	0.15 ÷ 10.60k	0.01	
40A ≤ FS ≤ 100	0.15 ÷ 26.50k	0.1	
100A ≤ FS ≤ 1000	1.5 ÷ 265.0k	1	

### Active clamp (@ 230V single phase systems 1Ph, cosφ=1, f=50/60Hz)

FS clamp	Range [kW]	Resolution [kW]	Accuracy
≤ 10A	0.000 ÷ 9.999	0.001	±(2.0%rdg + 5 dgt)
10A ≤ FS ≤ 200	0.00 ÷ 999.99	0.01	
200A ≤ FS ≤ 1000	0.0 ÷ 999.9	0.1	
1000A ≤ FS ≤ 3000	0 ÷ 9999	1	

**Reactive clamp (@ 230V single phase systems 1Ph,  $\cos\phi=0$ ,  $f=50/60\text{Hz}$ )**

FS clamp	Range [kVAr]	Resolution [kVAr]	Accuracy
$\leq 10\text{A}$	0.000 ÷ 9.999	0.001	$\pm(2.0\%\text{rdg} + 5 \text{ dgt})$
$10\text{A} \leq \text{FS} \leq 200$	0.00 ÷ 999.99	0.01	
$200\text{A} \leq \text{FS} \leq 1000$	0.0 ÷ 999.9	0.1	
$1000\text{A} \leq \text{FS} \leq 3000$	0 ÷ 9999	1	

**Apparent power (@ 230V single phase systems 1Ph,  $\cos\phi=0$ ,  $f=50/60\text{Hz}$ )**

FS clamp	Range [kVA]	Resolution [kVA]	Accuracy
$\leq 10\text{A}$	0.000 ÷ 9.999	0.001	$\pm(2.0\%\text{rdg} + 5 \text{ dgt})$
$10\text{A} \leq \text{FS} \leq 200$	0.00 ÷ 999.99	0.01	
$200\text{A} \leq \text{FS} \leq 1000$	0.0 ÷ 999.9	0.1	
$1000\text{A} \leq \text{FS} \leq 3000$	0 ÷ 9999	1	

**Power factor (@ 230V single phase systems 1Ph,  $f=50/60\text{Hz}$ , current  $\geq 10\%\text{FS}$ )**

Range	Resolution	Accuracy
0.70c ÷ 1.00 ÷ 0.70i	0.01	$\pm(2.0\%\text{rdg} + 3\text{dgt})$

 **$\cos\phi$  (@ 230V single phase systems 1Ph,  $f=50/60\text{Hz}$ , current  $\geq 10\%\text{FS}$ )**

Range	Resolution	Accuracy
0.70c ÷ 1.00 ÷ 0.70i	0.01	$\pm(2.0\%\text{rdg} + 3\text{dgt})$

**Voltage harmonics (@ 230V single phase systems 1Ph,  $f=50/60\text{Hz}$ )**

Range [%]	Resolution [%]	Order	Accuracy
0.1 ÷ 100.0	0.1	00, 02 ÷ 25	$\pm(5.0\%\text{rdg} + 5\text{dgt})$

Fundamental frequency: 50/60Hz  $\pm 5\%$

Harmonics are zeroed in the followed conditions:

- > DC : if the DC value <0.5% fundamental value or if the DC value < 1.0V
- > 1° harmonic: if the value of 1°harmonic < 15V (not displayed)
- > 2nd ÷ 25th harmonics: if harmonic value <0.5% fundamental value or if the value < 1.0V

**Current harmonics ( $f=50/60\text{Hz}$ )**

Range [%]	Resolution [%]	Order	Accuracy
0.1 ÷ 100.0	0.1	00, 02 ÷ 25	$\pm(5.0\%\text{rdg} + 5\text{dgt})$

Harmonics are zeroed in the followed conditions:

- > DC : if the DC value <0.5% fundamental value or if the DC value < 5mV
- > 1° harmonic: if the value of 1°harmonic <5mV (not displayed)
- > 2nd ÷ 25th harmonics: if harmonic value <0.5% fundamental value or if the value <5mV

## 10.2. GENERAL CHARACTERISTICS

### Reference guidelines

Safety:	IEC/EN61010-1, IEC/EN61010-2-030, IEC/EN61010-2-033 IEC/EN61010-2-034, IEC/EN61557-1
EMC:	IEC/EN61326-1, IEC/EN61326-2-2
Technical documentation:	IEC/EN61187
Safety of accessories:	IEC/EN61010-031
EMC environment of use:	portable, Class B, Group 1
Insulation:	double insulation
Pollution level:	2
Max. operating altitude:	2000m (6562ft)
Measurement category:	CAT IV 300V to earth, maximum 415V between inputs
RPE:	IEC/EN61557-4, BS7671 17th/18th ed., AS/NZS3000/3017
MΩ:	IEC/EN61557-2, BS7671 17th/18th ed., AS/NZS3000/3017
RCD:	IEC/EN61557-6 (only on Phase-Neutral-Earth systems)
RCD-DD:	IEC62955
RCD CCID:	UL 2231-2
LOOP L-L, L-N, L-PE:	IEC/EN61557-3, BS7671 17th/18th ed., AS/NZS3000/3017
Multifunction:	IEC/EN61557-10, BS7671 17th/18th ed., AS/NZS3000/3017
Short-circuit current:	EN60909-0

### Radio

Compliance RED directive:	ETSI EN300328, ETSI EN301489-1, ETSI EN301489-17
---------------------------	--

### Mechanical characteristics

Dimensions (L x W x H):	225 x 165 x 75mm ; (9 x 6 x 3in)
Weight (batteries included):	1.2kg ; (42 ounces)
Mechanical protection:	IP40

### Power supply

Battery type:	6x1.5V alkaline batteries type AA IEC LR06 MN1500 or 6 x1.2V rechargeable NiMH type AA
Low battery indication:	low battery symbol  on the display
Battery life:	> 500 tests for each function
Auto Power OFF:	after 10 minutes' idling (if activated)

### Miscellaneous

Display:	COG Black/white graphic LCD, 320x240pxl
Memory:	999 locations, 3 mark levels
PC connection:	optical/USB port and WiFi

## 10.3. ENVIRONMENTAL CONDITIONS FOR USE

Reference temperature:	23°C ± 5°C ; (73°F ± 41°F)
Operating temperature:	0°C ÷ 40°C ; (32°F ÷ 104°F)
Allowable relative humidity:	<80%RH
Storage temperature:	-10°C ÷ 60°C ; (14°F ÷ 140°F)
Storage humidity:	<80%RH

**This instrument satisfies the requirements of Low Voltage Directive 2014/35/EU (LVD), EMC Directive 2014/35/EU and RED 2014/53/EU**  
**This instrument satisfies the requirements of European Directive 2011/65/EU (RoHS) and 2012/19/EU (WEEE)**

## 10.4. ACCESSORIES

See enclosed packing list

## 11. SERVICE

### 11.1. WARRANTY CONDITIONS

This instrument is warranted against any material or manufacturing defect, in compliance with the general sales conditions. During the warranty period, defective parts may be replaced. However, the manufacturer reserves the right to repair or replace the product. Should the instrument be returned to the After-sales Service or to a Dealer, transport will be at the Customer's charge. However, shipment will be agreed in advance. A report will always be enclosed to a shipment, stating the reasons for the product's return. Only use original packaging for shipment. Any damage due to the use of non-original packaging material will be charged to the Customer. The manufacturer declines any responsibility for injury to people or damage to property.

The warranty shall not apply in the following cases:

- Repair and/or replacement of accessories and battery (not covered by warranty).
- Repairs that may become necessary as a consequence of an incorrect use of the instrument or due to its use together with non-compatible appliances.
- Repairs that may become necessary as a consequence of improper packaging.
- Repairs which may become necessary as a consequence of interventions performed by unauthorized personnel.
- Modifications to the instrument performed without the manufacturer's explicit authorization.
- Use not provided for in the instrument's specifications or in the instruction manual.

The content of this manual cannot be reproduced in any form without the manufacturer's authorization.

**Our products are patented and our trademarks are registered. The manufacturer reserves the right to make changes in the specifications and prices if this is due to improvements in technology.**

### 11.2. SERVICE

If the instrument does not operate properly, before contacting the After-sales Service, please check the conditions of batteries and cables and replace them, if necessary. Should the instrument still operate improperly, check that the product is operated according to the instructions given in this manual. Should the instrument be returned to the After-sales Service or to a Dealer, transport will be at the Customer's charge. However, shipment will be agreed in advance. A report will always be enclosed to a shipment, stating the reasons for the product's return. Only use original packaging for shipment; any damage due to the use of non-original packaging material will be charged to the Customer.

## 12. THEORETICAL APPENDIXES

### 12.1. CONTINUITY OF PROTECTIVE CONDUCTORS

Check the continuity of:

- Protective conductors (PE), main equalizing potential conductors (EQP), secondary equalizing potential conductors (EQS) in TT and TN-S systems
- Neutral conductors having functions of protective conductors (PEN) in TN-C systems.

This test is to be preceded by a visual check verifying the existence of yellow-green protective and equalizing potential conductors as well as compliance of the sections used with the standards requirements.

#### Parts of the system to be checked

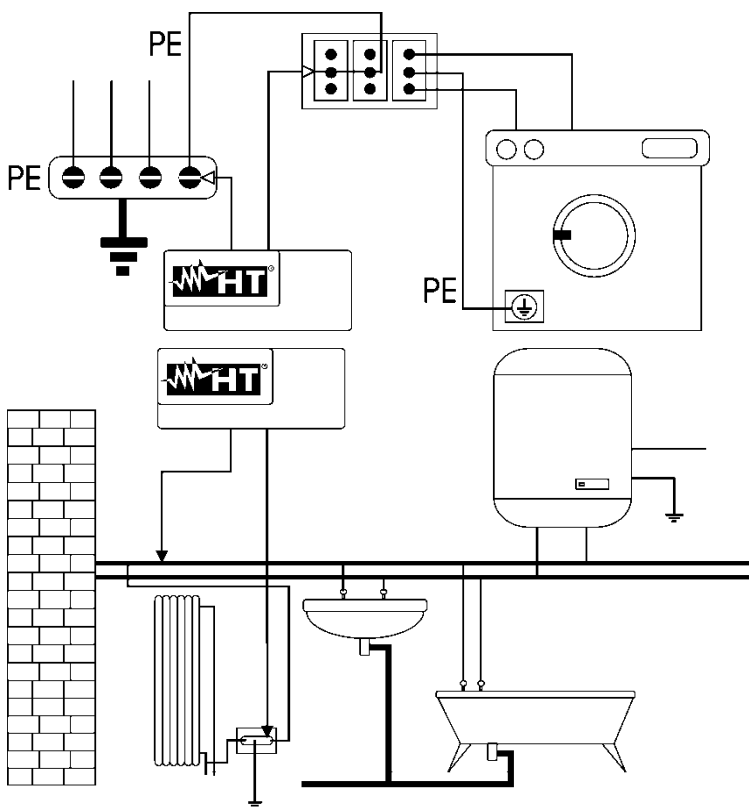

Connect one of the test leads to the protective conductor of the socket and the other to the equalizing potential node of the earth installation.

Connect one of the test leads to the external mass (in this case the water pipe) and the other to the earth installation using, for example, the protective conductor of the closest socket.

Fig. 43: Examples for continuity measurements on conductors

Check the continuity among:

- Earth poles of all the plug sockets and earth collector or node
- Earth terminals of class I appliances (boilers, etc.) and earth collector or node
- Main external masses (water tubes, gas pipes, etc.) and earth collector or node
- Additional external masses between each other and to earth terminal.

#### Allowable values

The standards do not require the measurement of continuity resistance and the comparison of the results with limit values. The standards simply require that the instrument in use warns the operator if the test was not carried out with a current of at least 200mA and an open-circuit voltage ranging from 4 to 24V. The resistance values may be calculated according to the sections and lengths of the conductors under test. In general, if the instrument detects values of some ohms, the test may be considered as successful.

## 12.2. INSULATION RESISTANCE

### Purpose of the test

Check that the insulation resistance of the installation complies with the requirements of the applicable guidelines. This test has to be performed with the circuit being tested not powered and with the possible loads it supplies disconnected.

### **Allowable values**

The values of the measured voltage and of the minimum insulation resistance can be taken from the following table.

Circuit nominal voltage [V]	Test voltage [V]	Insulation resistance [MΩ]
SELV and PELV *	250	≥ 0,250
Up to/equal to 500 V, except for the above-mentioned circuits	500	≥ 1,000
Over 500 V	1000	≥ 1,000

\* The terms SELV and PELV replace, in the standards' new wording, the old definitions of "Very low safety voltage" or "Very low functional voltage".

Table 4: Most common test types, insulation resistance measurement

### **Parts of the system to be checked**

Check the insulation resistance between:

- Each active conductor and the earth (the neutral conductor is considered as an active conductor except in TN-C power supply systems, where it is considered as part of the earthing (PEN)). During this measurement, all active conductors may be connected to each other. Should the measurement's result be outside the limits prescribed by the standards, the test must be repeated separately for each single conductor.
- The active conductors. The guidelines recommend also checking the insulation between active conductors when possible.

If the system includes electronic devices, it is necessary to disconnect them from the system to prevent any damage. Should this not be possible, only perform the test between active conductors (which, in this case, must be connected to each other) and the earth connection.

In the presence of a very extended circuit, wires running side by side constitute a capacity that the instrument must load in order to obtain a correct measurement; in this case, it is advisable to hold the start button of the measurement (in case you run the test in manual mode) until the result is stable.

The "> full scale" message indicates that the insulation resistance measured by the instrument is higher than the maximum measurable resistance; this result is obviously much higher than the minimum limits indicated in the standard table above, so the insulation at that point is to be considered compliant.

### 12.2.1. Measurement of polarization index (PI)

The purpose of this diagnostic test is to evaluate the influence of the polarization effects. Upon the application of a high voltage to insulation, the electric dipoles distributed in the insulation align in the direction of the applied electric field. This phenomenon is called polarization. Because of the polarized molecules, a polarization (absorption) current generates, which lowers the total value of insulation resistance.

Parameter **PI** consists in the ratio between the value of insulation resistance measured after 1 minute and after 10 minutes. The test voltage is maintained throughout the whole duration of the test and, at the end, the instrument provides the value of ratio:

$$PI = \frac{R (10 \text{ min})}{R (1 \text{ min})}$$

Some reference values:

PI Value	Insulation condition
<1.0	Not acceptable
from 1.0 to 2.0	Dangerous
from 2.0 to 4.0	Good
> 4.0	Excellent

### 12.2.2. Dielectric Absorption Ratio (DAR)

Parameter **DAR** consists in the ratio between the value of insulation resistance measured after 30s and after 1 minute. The test voltage is maintained throughout the whole duration of the test and, at the end, the instrument provides the value of ratio:

$$DAR = \frac{R (1 \text{ min})}{R (30s)}$$

Some reference values:

DAR Value	Insulation condition
< 1.0	Not acceptable
from 1.0 to 1.25	Dangerous
from 1.25 to 1.6	Good
> 1.6	Excellent

### 12.3. CHECKING CIRCUIT SEPARATION

A **SELV** system is a zero-category system or safety extra low voltage system characterized by power supply from an independent (e.g. batteries, small generator set) or safety source (e.g. safety transformer), protective separation from other electrical systems (double or reinforced insulation or earthed metal screen) and absence of earthed points (insulated from the earth).

A **PELV** system is a zero-category system or protective extra low voltage system characterized by power supply from an independent (e.g. batteries, small generator set) or safety source (e.g. safety transformer), protective separation from other electrical systems (double or reinforced insulation or earthed metal screen) and, unlike **SELV** systems, presence of earthed points (not insulated from the earth).

A system with **Electrical Separation** is a system characterized by a power supply from an insulation transformer or independent source with equivalent characteristics (e.g. motor generator set), protective separation from other electrical systems (insulation no lower than that of the insulation transformer), protective separation to earth (insulation no lower than that of the insulation transformer).

#### **Purpose of the test**

The test, to be performed if protection is obtained through separation, must check that the insulation resistance measured as described below (according to the type of separation) complies with the limits reported in the table relating to insulation measurements.

#### **Parts of the system to be checked**

- **SELV System (Safety Extra Low Voltage):**
  - ✓ Measure the resistance between the active parts of the circuit being tested (separated) and the active parts of the other circuits.
  - ✓ Measure the resistance between the active parts of the circuit to be tested (separated) and the earth.
- **PELV System (Protective Extra Low Voltage):**
  - ✓ Measure the resistance between the active parts of the circuit being tested (separated) and the active parts of the other circuits.
- **Electrical separation:**
  - ✓ Measure the resistance between the active parts of the circuit being tested (separated) and the active parts of the other circuits.
  - ✓ Measure the resistance between the active parts of the circuit to be tested (separated) and the earth.

#### **Allowable values**

The test has a positive result when the insulation resistance shows values higher or equal to those indicated in Table 4

**EXAMPLE OF SEPARATION TEST BETWEEN ELECTRICAL CIRCUITS**

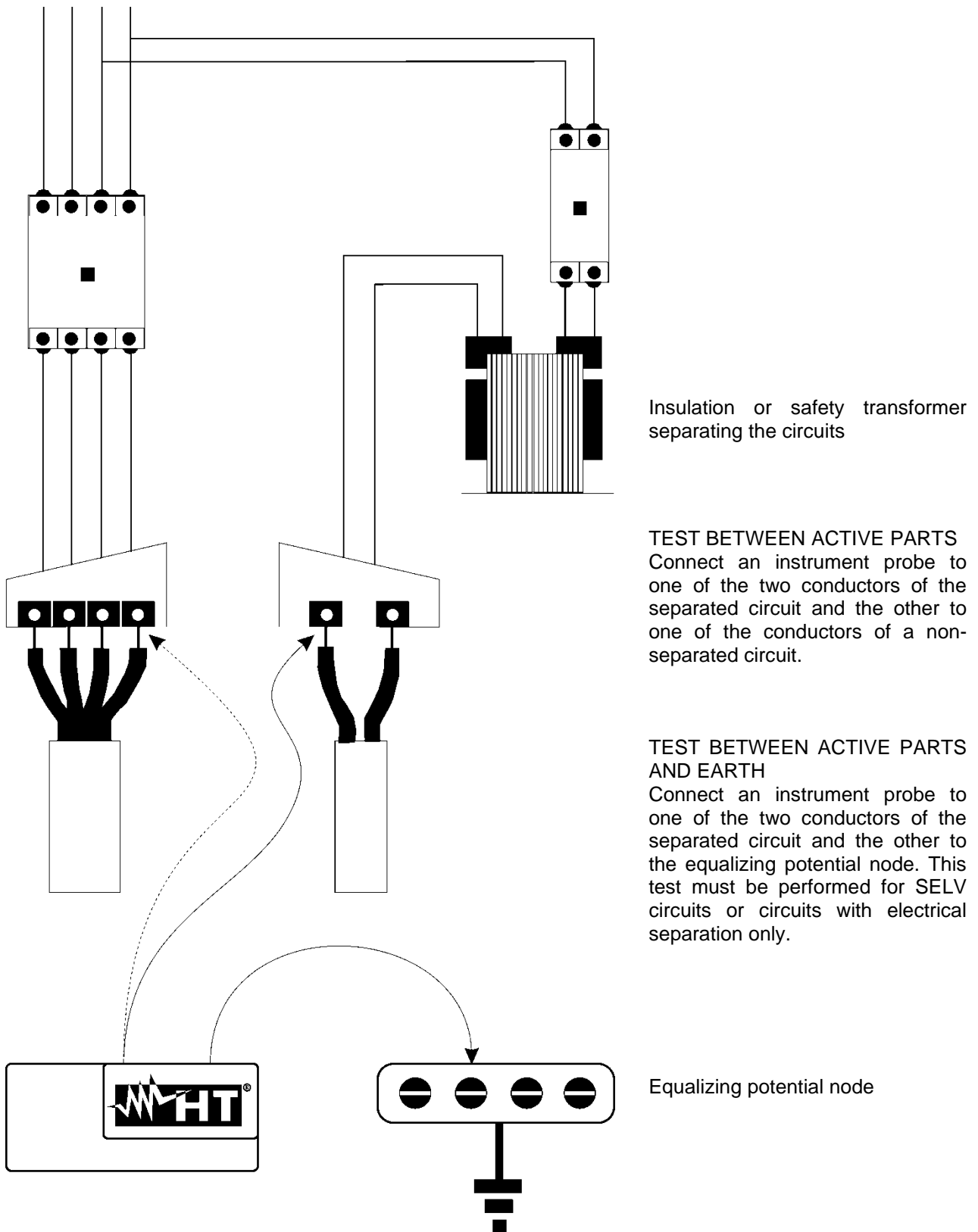

Fig. 44: Separation measurements between the circuits of a system

## 12.4. TEST ON DIFFERENTIAL SWITCHES (RCD)

### Purpose of the test

Checking that the General (G) and Selective (S) differential protection devices have been correctly installed and adjusted and that they maintain their characteristics over time. The check must make sure that the differential switch trips at a current not higher than its nominal operating current  $I_{dN}$  and that the tripping time meets the following conditions, according to the case:

- The tripping time does not exceed the maximum time as prescribed by the standard for differential switches of a General type (according to what described in Table 5)
- The tripping time is between the minimum and the maximum tripping time for differential switches of a Selective type (according to what described in Table 5)

The differential switch test performed with the test key helps so that no “gluing effect” jeopardizes the operation of the device if it has remained unused for a long time. This test is only performed to ascertain the mechanical functionality of the device and it is not sufficient to declare the device’s conformity to the standard regarding differential current devices. According to statistics, switch verification through test key, if performed once a month, reduces to a half the device’s malfunction rate. However, this test only detects 24% of the defective differential switches.

### Parts of the system to be checked

All differential switches must be tested upon installation. In low-voltage systems, it is advisable to perform this test, fundamental in order to guarantee a correct safety level. In medical rooms, this test must be performed periodically on all differential switches as prescribed by the guidelines.

### Allowable values

On each molded-case RCD, two tests must be performed on each differential switch: a test with a leakage current beginning in phase with the positive half-wave of voltage ( $0^\circ$ ) and a test with a leakage current beginning in phase with the negative half-wave of voltage ( $180^\circ$ ). The result to be considered is the higher one. The test with  $\frac{1}{2}I_{dN}$  must not cause the differential switch tripping.

RCD type	$I_{dN} \times 1$	$I_{dN} \times 5^*$	Description
General	0.3s	0.04s	Maximum tripping time in seconds
Selective S	0.13s	0.05s	Minimum tripping time in seconds
	0.5s	0.15s	Maximum tripping time in seconds

Table 5: Tripping times for general and selective differential switches

### Trip-out times’ compliance with AS/NZS 3017 guideline (\*\*)

RCD type	$I_{dN}$ [mA]	$\frac{1}{2} I_{dN} (*)$	$I_{dN}$	$5 \times I_{dN}$	Note
		$t\Delta$ [ms]			
I	$\leq 10$	>999ms	40		Maximum tripping time
II	$> 10 \leq 30$		300	40	
III	$> 30$		500	150	
IV [S]	$> 30$		130	50	Minimum non-tripping time

Table 6: Tripping times for general and selective differential switches in AUS/NZ country

(\*) Minimum test period for current of  $\frac{1}{2} I_{dN}$ , RCD shall not trip

(\*\*) Test current and measurement accuracy correspond to AS/NZS 3017 requirements

## Measurement of tripping current for protection differential switches

- This test aims at checking the real tripping current of general differential switches (**it does not apply to selective differential switches**).
- In the presence of differential switches with selectable tripping current, it is useful to perform this test in order to check the real tripping current of the differential switch. For differential switches with fixed differential current, this test may be performed in order to detect possible leakages of the users connected to the system.
- Should an earth system not be available, perform the test by connecting the instrument to a terminal on a conductor downstream of the differential device and a terminal on the other conductor upstream of the device.
- Tripping current must be between  $\frac{1}{2}I_{dn}$  and  $I_{dn}$

## 12.5. VERIFICATION OF THE BREAKING CAPACITY OF PROTECTION DEVICES

### Purpose of the test

Checking that the breaking capacity of the protection device is higher than the maximum fault current possible in the system.

### Parts of the system to be checked

The test must be performed at the point in which the maximum short-circuit current is possible, normally immediately downstream of the protection device to be checked.

The test must be performed between phase and phase ( $Z_{pp}$ ) in three-phase systems and between phase and neutral ( $Z_{pn}$ ) in single-phase systems.

### Allowable values

The instrument performs the comparison between the measured value and the value calculated according to the following relationships:

$$BC > I_{MAX\ 3\Phi} = C_{MAX} \cdot \frac{\frac{U_{L-L}^{NOM}}{\sqrt{3}}}{\frac{Z_{L-L}}{2}}$$

**Three-phase systems**

$$BC > I_{MAX\ L-N} = C_{MAX} \cdot \frac{U_{L-N}^{NOM}}{Z_{L-N}}$$

**Single-phase systems**

where: BC = breaking capacity of protection device  
 $Z_{LL}$  = Impedance measured between phase and phase  
 $Z_{LN}$  = Impedance measured between phase and neutral

Measured voltage	$U_{NOM}$	$C_{MAX}$
$230V-10\% < V_{measured} < 230V+10\%$	230V	1.05
$230V+10\% < V_{measured} < 400V-10\%$	$V_{measured}$	1.10
$400V-10\% < V_{measured} < 400V+10\%$	400V	1.05

## 12.6. VERIFY OF PROTECTION AGAINST INDIRECT CONTACTS IN TN SYSTEMS

### Purpose of the test

Protection against indirect contacts in TN systems must be guaranteed by means of a protection device against overcurrents (typically MCB or fuse), which switches off the power supply of the circuit or the electrical equipment in case of faults between an active part and a ground mass or a protection conductor within a interval not exceeding 5s, sufficient for the equipments, or in compliance with the times declared in the following Table. 7. For other countries, please refer to the respective guidelines.

U <sub>o</sub> [V]	Trip-out time of protection [s]
50 ÷ 120	0.8
120 ÷ 230	0.4
230 ÷ 400	0.2
>400	0.1

Table 7: Tripping times for protection devices

U<sub>o</sub> = nominal AC voltage referred to the system's ground

The above condition is satisfied by the following relationship:

$$Z_s * I_a \leq U_o$$

where:

Z<sub>s</sub> = Fault Loop P-PE impedance which includes the phase winding of the transformer, the line conductor up to the fault point and the protective conductor from the fault point to the star center of the transformer

I<sub>a</sub> = Tripping current of the protection device within the time specified in Table 7

U<sub>o</sub> = nominal AC voltage referred to ground

### CAUTION



The instrument must be used to measure fault loop impedance values at least 10 times higher than the resolution value of the instrument in order to minimize errors.

### Parts of the system to be checked

The test must necessarily be performed on TN and IT systems not protected by differential devices.

### Allowable values

The measurement is aimed at ensuring that, in every point of the system, the following relationships are satisfied:

$$I_a \leq I_{MIN P-PE} = C_{MIN} \cdot \frac{U_{P-PE}^{NOM}}{Z_{P-PE}}$$

Measured voltage	U <sub>NOM</sub>	C <sub>MIN</sub>
230V-10% < V <sub>measured</sub> < 230V+ 10%	230V	0.95
230V+10% < V <sub>measured</sub> < 400V- 10%	V <sub>measured</sub>	1.00
400V-10% < V <sub>measured</sub> < 400V+ 10%	400V	0.95

Depending on the set values of phase-phase, phase-neutral or phase-PE voltage (see § 5.1.3) and the measured value of fault loop impedance, the instrument calculates the **minimum value** of the prospective short-circuit current to be interrupted by the protection device. For proper coordination, this value **MUST** always be greater than or equal to the **I<sub>a</sub>** value of the tripping current of the type of protection considered as worst case

The **I<sub>a</sub>** reference value (see Fig. 45) depends on:

- Protection type (curve B, C, D, K)
- Rated current of the protection device I<sub>n</sub>
- Time of fault extinction by the protection

Typically: I<sub>a</sub> = 3÷5I<sub>n</sub> (curve B), I<sub>a</sub> = 5÷10I<sub>n</sub> (curve C), I<sub>a</sub> = 10÷20I<sub>n</sub> (curves D,K)

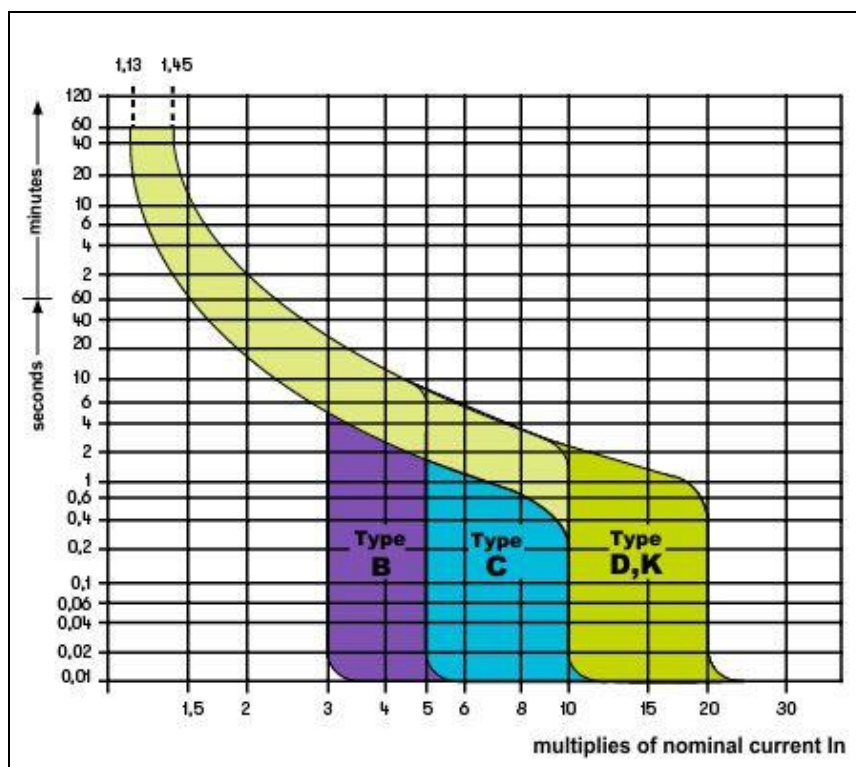

Fig. 45: Example of curves relative to magnetothermal (MCB) protection

The instrument allows the selection (\*) of the following parameters:

- **MCB curve B** → 3A, 6A, 10A, 13A, 15A, 16A, 20A, 25A, 32A, 40A, 45A, 50A, 63A, 80A, 100A, 125A, 160A, 200A
- **MCB curve C** → 0.5A, 1A, 1.6A, 2A, 3A, 4A, 6A, 10A, 13A, 15A, 16A, 20A, 25A, 32A, 40A, 50A, 63A, 80A, 100A, 125A, 160A, 200A
- **MCB curve D, K** → 0.5A, 1A, 1.6A, 2A, 3A, 4A, 6A, 10A, 13A, 15A, 16A, 20A, 25A, 32A, 40A, 45A, 50A, 63A, 80A, 100A, 125A, 160A, 200A
- **Fuse gG** → 2A, 4A, 6A, 8A, 10A, 12A, 13A, 16A, 20A, 25A, 32A, 35A, 40A, 50A, 63A, 80A, 100A, 125A, 160A, 200A, 250A, 315A, 400A, 500A, 630A, 800A, 1000A, 1250A
- **Fuse aM** → 2A, 4A, 6A, 10A, 12A, 16A, 20A, 25A, 32A, 35A, 40A, 50A, 63A, 80A, 100A, 125A, 160A, 200A, 250A, 315A, 400A, 500A, 630A
- Time of fault extinction by the protection selectable among: **0.1s, 0.2s, 0.4s, 1s, 5s**

(\*) The values could be subject to variations

## 12.7. RA TEST IN TN SYSTEMS

Protection against indirect contacts in TN systems must be guaranteed by means of a protection device against overcurrents (typically MCB or fuse) which switches off the power supply of the circuit or the electrical equipment in case of faults between an active part and a ground mass or a protection conductor within a interval not exceeding 5s, sufficient for the equipments.

### Parts of the system to be checked

The test must be performed at the point in which the minimum short-circuit current is possible, normally immediately downstream of the protection device to be checked.

The test must be performed between phase and PE ( $Z_{L-PE}$ ) and between phase and neutral ( $Z_{L-N}$ ) in three-phase systems or single-phase systems.

### Allowable values

The measurement is aimed at ensuring that, in every point of the system, the following relationships are satisfied:

$$Z_{L-PE} \leq Z_{LIM} \quad (1)$$

$$Z_{L-N} \leq Z_{LIM} \quad (2)$$

where:

- $Z_{L-PE}$  = Impedance measured between phase and PE
- $Z_{L-N}$  = Impedance measured between phase and neutral
- $Z_{LIM}$  = Maximum limit impedance depending on type (MCB or Fuse) and tripping time of the selected protection (values depending on countries)

The following selections (\*) are available on the instrument:

- **MCB curve B** → 3A, 6A, 10A, 13A, 15A, 16A, 20A, 25A, 32A, 40A, 45A, 50A, 63A, 80A, 100A, 125A, 160A, 200A
- **MCB curve C** → 0.5A, 1A, 1.6A, 2A, 3A, 4A, 6A, 10A, 13A, 15A, 16A, 20A, 25A, 32A, 40A, 50A, 63A, 80A, 100A, 125A, 160A, 200A
- **MCB curve D, K** → 0.5A, 1A, 1.6A, 2A, 3A, 4A, 6A, 10A, 13A, 15A, 16A, 20A, 25A, 32A, 40A, 45A, 50A, 63A, 80A, 100A, 125A, 160A, 200A
- **Fuse gG** → 2A, 4A, 6A, 8A, 10A, 12A, 13A, 16A, 20A, 25A, 32A, 35A, 40A, 50A, 63A, 80A, 100A, 125A, 160A, 200A, 250A, 315A, 400A, 500A, 630A, 800A, 1000A, 1250A
- **Fuse aM** → 2A, 4A, 6A, 10A, 12A, 16A, 20A, 25A, 32A, 35A, 40A, 50A, 63A, 80A, 100A, 125A, 160A, 200A, 250A, 315A, 400A, 500A, 630A
- Time of fault extinction by the protection selectable among: **0.1s, 0.2s, 0.4s, 1s, 5s**

(\*) The values could be subject to variations

## 12.8. VERIFY OF PROTECTION AGAINST INDIRECT CONTACTS IN TT SYSTEMS

### Purpose of the test

Checking that the protection device is coordinated with the value of earth resistance. We cannot assume a priori a reference limit value for earth resistance when checking the measurement's result. It is necessary to check each time that the coordination prescribed by the standard is met.

### Parts of the system to be checked

Earth installation in operating conditions. The test must be performed without disconnecting the earth rods.

### Allowable values

The value of earth resistance, however measured, must satisfy the following relationship:

$$R_A < 50 / I_a$$

where:  $R_A$  = resistance measured of earth installation whose value can be determined with the following measurements:

- Impedance of the fault ring (\*)
- Earth resistance with two wires in socket (\*\*)
- Earth resistance obtained by the measurement of contact voltage  $U_t$  (\*\*)
- Earth resistance obtained by the tripping time test of the RCDs (A, AC), RCD S (A, AC) (\*\*)

$I_a$  = tripping current of the automatic RCD or rated tripping current of the RCD (in case of RCD S 2 IdN) in Ampere

50 = safety limit voltage (reduced down to 25V in special environments)

(\*) If the system protection is obtained through a differential switch, the measurement must be performed upstream of this switch or downstream of it by short-circuiting the switch in order to prevent it from tripping.

(\*\*) These methods, although not currently provided for by guidelines, provide values that have been proven indicative of the earth resistance by numerous comparisons with the three-wire method.

### EXAMPLE OF EARTH RESISTANCE CHECK

System protected by a 30mA differential switch.

- Let us measure the earth resistance by using one of the above-mentioned methods.
- In order to understand if the system resistance is to be considered as compliant with the standards, we need to multiply the value found by 0.03A (30mA).
- If the result is lower than 50V (or 25V for special environments), the system can be considered as coordinated, as it satisfies the relationship indicated above.
- When dealing with 30mA differential switches (as in almost all private systems), the maximum allowable earth resistance is  $50/0.03=1666\Omega$ . This enables using also the indicated simplified methods which, although they do not provide an extremely precise value, provide a sufficiently approximated value for coordination calculation.

## 12.9. VERIFY OF PROTECTION AGAINST INDIRECT CONTACTS IN IT SYSTEMS

In IT systems, the active parts must be isolated from the ground or be connected to earth through an impedance of sufficiently high value. In case of a single earth fault, the first fault current is weak, and therefore it is not necessary to interrupt the circuit. This connection can be made to the neutral point of the system or to an artificial neutral point. If there is no neutral point, connection can be made to earth through the impedance of a line conductor. It is however necessary to take precautions to avoid the risk of harmful physiological effects on people in contact with conductive parts simultaneously accessible in case of a double earth fault.

### **Purpose of the test**

Verifying that the impedance of the ground probe which the masses are connected to satisfies the following relationship:

$$Z_E * I_d \leq U_L$$

where:

- $Z_E$  = L-PE impedance of the ground probe to which the masses are connected
- $I_d$  = L-PE current of first fault (typically expressed in mA)
- $U_L$  = Limit contact voltage 25V or 50V

### **Parts of the system to be checked**

The earth system under operating conditions. The verification should be performed without disconnecting the ground probes.

## 12.10. VERIFY OF PROTECTION COORDINATION L-L, L-N AND L-PE

### Purpose of the test

Testing the coordination of protective devices (typically MCB or fuse) present in a single-phase or three-phase installation as a function of the limit time of fault extinction by the protection set by the user and the calculated value of the short-circuit current.

### Parts of the system to be checked

The test must be performed at the point in which the minimum short-circuit current is possible, normally at the end of the line controlled by the protection device in the normal condition of the line. The test must be performed between Phase-Phase in three-phase installations and between Phase-PE or Phase-PE in single-phase installations.

### Allowable values

The instrument performs the comparison between the calculated value of short-circuit current and the  $I_a$  = tripping current of the protection device within the specified time, according to the following expressions:

$$I_{SCL-L\_Min2\Phi} > I_a \quad \text{Three-phase system} \rightarrow \text{Loop L-L impedance}$$

$$I_{SCL-N\_Min} > I_a \quad \text{Single-phase system} \rightarrow \text{Loop L-N impedance}$$

$$I_{SCL-PE\_Min} > I_a \quad \text{Single-phase system} \rightarrow \text{Loop L-PE impedance}$$

where:

- Isc L-L\_Min2F = Prospective short-circuit current minimum double phase L-L
- Isc L-N\_Min = Prospective short-circuit current minimum L-N
- Isc L-PE\_Min = Prospective short-circuit current minimum L-PE

The calculation of prospective short-circuit current is performed by the instrument based on the fault loop impedance measurement in compliance with the following relationships:

$$I_{SCL-L\_Min2\Phi} = C_{MIN} \cdot \frac{U_{L-L}^{NOM}}{Z_{L-L}} \quad I_{SCL-N\_Min} = C_{MIN} \cdot \frac{U_{L-N}^{NOM}}{Z_{L-N}} \quad I_{SCL-PE\_Min} = C_{MIN} \cdot \frac{U_{L-PE}^{NOM}}{Z_{L-PE}}$$

**Phase – Phase**

**Phase – Neutral**

**Phase – PE**

Measured voltage	$U_{NOM}$	$C_{MIN}$
$230V-10\% < V_{measured} < 230V+ 10\%$	230V	0,95
$230V+10\% < V_{measured} < 400V- 10\%$	$V_{measured}$	1,00
$400V-10\% < V_{measured} < 400V+ 10\%$	400V	0,95

where:

- U L-L = Nominal Phase-Phase voltage
- U L-N = Nominal Phase-Neutral voltage
- U L-PE = Nominal Phase-PE voltage
- Z L-L = Measured Phase-Phase Impedance
- Z L-N = Measured Phase-Neutral Impedance
- Z L-PE = Measured Phase-PE Impedance

**CAUTION**

The instrument must be used to measure fault loop impedance values at least 10 times higher than the resolution value of the instrument in order to minimize errors.

Depending on the set values of nominal voltage (see § 5.1.3) and the measured value of fault loop impedance, the instrument calculates the **minimum value** of the prospective short-circuit current to be interrupted by the protection device. For proper coordination, this value **MUST** always be greater than or equal to the **I<sub>a</sub>** value of the tripping current of the type of protection considered.

The **I<sub>a</sub>** reference value depends on:

- Protection type (curve)
- Rated current of the protection device
- Time of fault extinction by the protection

The instrument allows the selection (\*) of the following parameters:

- **MCB curve B** → 3A, 6A, 10A, 13A, 15A, 16A, 20A, 25A, 32A, 40A, 45A, 50A, 63A, 80A, 100A, 125A, 160A, 200A
- **MCB curve C** → 0.5A, 1A, 1.6A, 2A, 3A, 4A, 6A, 10A, 13A, 15A, 16A, 20A, 25A, 32A, 40A, 50A, 63A, 80A, 100A, 125A, 160A, 200A
- **MCB curve D, K** → 0.5A, 1A, 1.6A, 2A, 3A, 4A, 6A, 10A, 13A, 15A, 16A, 20A, 25A, 32A, 40A, 45A, 50A, 63A, 80A, 100A, 125A, 160A, 200A
- **Fuse gG** → 2A, 4A, 6A, 8A, 10A, 12A, 13A, 16A, 20A, 25A, 32A, 35A, 40A, 50A, 63A, 80A, 100A, 125A, 160A, 200A, 250A, 315A, 400A, 500A, 630A, 800A, 1000A, 1250A
- **Fuse aM** → 2A, 4A, 6A, 10A, 12A, 16A, 20A, 25A, 32A, 35A, 40A, 50A, 63A, 80A, 100A, 125A, 160A, 200A, 250A, 315A, 400A, 500A, 630A
- Time of fault extinction by the protection selectable among: **0.1s, 0.2s, 0.4s, 1s, 5s**

(\*) The values could be subject to variations

### 12.11. VERIFY OF VOLTAGE DROP ON MAINS

Measurement voltage drop as a result of current flow through mains or a part of it can be very important. If necessary:

- Verify the capability of an existing mains line to supply a load
- Dimension a new installation
- Search for possible causes of troubles on devices, loads, etc. connected to mains

#### **Purpose of the test**

Measure the maximum percentage value of voltage drop between two points of mains.

#### **Parts of the system to be checked**

The test includes two sequential impedance measurements in the initial point of mains power line (typically downstream of a protection device) and in the final point of the same line.

#### **Allowable values**

The instrument compares the calculated value of  $\Delta V\%$  maximum voltage drop to the set limit value (according to applicable guidelines) according to the following relationship:

$$\Delta V\%_{MAX} = \frac{(Z_2 - Z_1) * I_{NOM}}{V_{NOM}} * 100$$

where:

- $Z_2$  = End point impedance of the mains being tested
- $Z_1$  = Initial point impedance (Offset) of the mains being tested ( $Z_2 > Z_1$ )
- $I_{NOM}$  = Nominal current of protection device of the mains being tested
- $V_{NOM}$  = Phase-Neutral or Phase-PE nominal voltage of the mains being tested

### 12.12. VOLTAGE AND CURRENT HARMONICS

Any periodical non-sine wave can be represented as a sum of sinusoidal waves having each a frequency that corresponds to an entire multiple of the fundamental, according to the relation:

$$v(t) = V_0 + \sum_{k=1}^{\infty} V_k \sin(\omega_k t + \varphi_k) \quad (1)$$

where:  $V_0$  = average value of  $v(t)$   
 $V_1$  = amplitude of the fundamental of  $v(t)$   
 $V_k$  = amplitude of the  $k^{\text{th}}$  harmonic of  $v(t)$

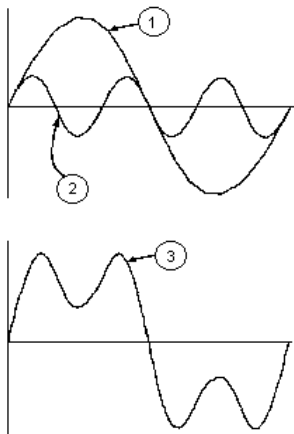

**CAPTION:**

1. Fundamental
2. Third harmonic
3. Distorted waveform

Fig. 46: Effect of the sum of two multiple frequencies

In the mains voltage, the fundamental has a frequency of 50 Hz, the second harmonic has a frequency of 100 Hz, the third harmonic has a frequency of 150 Hz and so on. Harmonic distortion is a constant problem and should not be confused with short events such as sags, surges or fluctuations.

It can be noted that in (1) the index of the sigma is from 1 to the infinite. What happens in reality is that a signal does not have an unlimited number of harmonics: a number always exists after which the harmonics value is negligible. The EN 50160 standard recommends to stop the index in the expression (1) in correspondence of the 40<sup>th</sup> harmonic. A fundamental element to detect the presence of harmonics is THD defined as:

$$THD_v = \frac{\sqrt{\sum_{h=2}^{40} V_h^2}}{V_1}$$

This index takes all the harmonics into account. The higher it is, the more distorted the waveform gets.

**Limit values for harmonics**

EN 50160 guideline fixes the limits for the harmonic voltages, which can be introduced into the network by the power supplier. In normal conditions, during whatever period of a week, 95% of the RMS value of each harmonic voltage, mediated on 10 minutes, will have to be inferior than or equal to the values stated in Table 1. The total harmonic distortion (THD) of the supply voltage (including all the harmonics up to 40<sup>th</sup> order) must be inferior than or equal to 8%.

Odd harmonics				Even harmonics	
Not multiple of 3		Multiple of 3		Order h	Relative voltage % Max
Order h	Relative voltage % Max	Order h	Relative voltage % Max		
5	6	3	5	2	2
7	5	9	1,5	4	1
11	3,5	15	0,5	6..24	0,5
13	3	21	0,5		
17	2				
19	1,5				
23	1,5				
25	1,5				

Table 1 Limits for the harmonic voltages the supplier may introduce into the network

These limits, theoretically applicable only for the supplier of electric energy, provide however a series of reference values within which the harmonics introduced into the network by the users must be contained.

#### 12.12.1. Presence of harmonics: causes

- Any apparatus that alters the sine wave or uses only a part of such a wave causes distortions to the sine wave and therefore harmonics. All current signals result in some way virtually distorted. The most common situation is the harmonic distortion caused by non-linear loads such as electric household appliances, personal computers or speed control units for motors. Harmonic distortion causes significant currents at frequencies that are odd multiples of the fundamental frequency. Harmonic currents affect considerably the neutral wire of electric installations.
- In most countries, the mains power is three-phase 50/60Hz with a delta primary and star secondary transformers. The secondary generally provides 230V AC from phase to neutral and 400V AC from phase to phase. Balancing the loads on each phase has always represented an headache for electric systems designers
- Until some ten years ago, in a balanced system, the vectorial sum of the currents in the neutral was zero or quite low (given the difficulty of obtaining a perfect balance). The devices were incandescent lights, small motors and other devices that presented linear loads. The result was an essentially sinusoidal current in each phase and a low current on the neutral at a frequency of 50/60Hz
- “Modern” devices such as TV sets, fluorescent lights, video machines and microwave ovens normally draw current for only a fraction of each cycle thus causing non-linear loads and subsequent non-linear currents. All this generates odd harmonics of the 50/60Hz line frequency. For this reason, the current in the transformers of the distribution boxes contains only a 50Hz (or 60Hz) component but also a 150Hz (or 180Hz) component, a 50Hz (or 300Hz) component and other significant components of harmonic up to 750Hz (or 900Hz) and higher
- The vectorial sum of the currents in a balanced system that feeds non-linear loads may still be quite low. However, the sum does not eliminate all current harmonics. The odd multiples of the third harmonic (called “TRIPLENS”) are added together in the neutral and can cause overheating even with balanced loads.

### 12.12.2. Presence of harmonics: consequences

In general, even harmonics, i.e. the 2<sup>nd</sup>, 4<sup>th</sup> etc., do not cause problems. Triple harmonics, odd multiples of three, are added on the neutral (instead of cancelling each other) thus creating a condition of overheating of the wire which is extremely dangerous. Designers should take into consideration the three issues given below when designing a power distribution system that will contain harmonic current:

- The neutral wire must be of sufficient gauge
- The distribution transformer must have an additional cooling system to continue operating at its rated capacity when not suited to the harmonics. This is necessary because the harmonic current in the neutral wire of the secondary circuit circulates in the delta-connected primary circuit. This circulating harmonic current heats up the transformer
- Phase harmonic currents are reflected on the primary circuit and continue back to the power source. This can cause distortion of the voltage wave so that any power factor correction capacitors on the line can be easily overloaded.

The 5<sup>th</sup> and the 11<sup>th</sup> harmonic contrast the current flow through the motors making its operation harder and shortening their average life. In general the higher the ordinal number, the smaller its energy is and therefore the impact it will have on the devices (except for transformers).

### 12.13. CALCULATION OF POWERS AND POWER FACTORS

The instrument measures the values of RMS Voltage and RMS Current and calculates the average Power values for each period. The formulas for power calculation are:

$$P = \frac{1}{N} \times \sum_{i=1}^N v_i \times i_i$$
$$S = \sqrt{\frac{1}{N} \times \sum_{i=1}^N v_i^2} \times \sqrt{\frac{1}{N} \times \sum_{i=1}^N i_i^2}$$
$$Q = \sqrt{S^2 - P^2}$$
$$Pf = \frac{P}{S}$$

where:

N = number of samples in the period



**HT ITALIA SRL**

Via della Boaria, 40  
48018 – Faenza (RA) – Italy  
T +39 0546 621002 | F +39 0546 621144  
M [ht@ht-instruments.com](mailto:ht@ht-instruments.com) | [www.ht-instruments.it](http://www.ht-instruments.it)

WHERE  
WE ARE



**HT INSTRUMENTS SL**

C/ Legalitat, 89  
08024 Barcelona – Spain  
T +34 93 408 17 77 | F +34 93 408 36 30  
M [info@htinstruments.es](mailto:info@htinstruments.es) | [www.ht-instruments.com/es-es/](http://www.ht-instruments.com/es-es/)

**HT INSTRUMENTS GmbH**

Am Waldfriedhof 1b  
D-41352 Korschenbroich – Germany  
T +49 (0) 2161 564 581 | F +49 (0) 2161 564 583  
M [info@ht-instruments.de](mailto:info@ht-instruments.de) | [www.ht-instruments.de](http://www.ht-instruments.de)